

Municipal castings

Ductile iron

Manhole covers

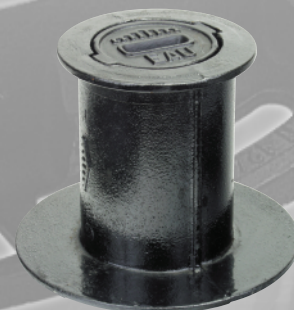
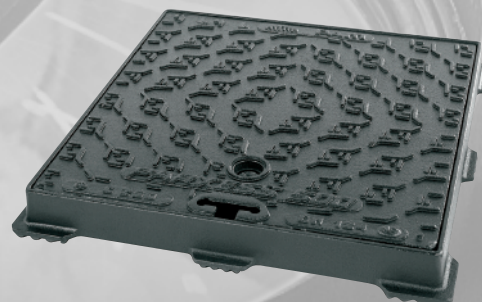
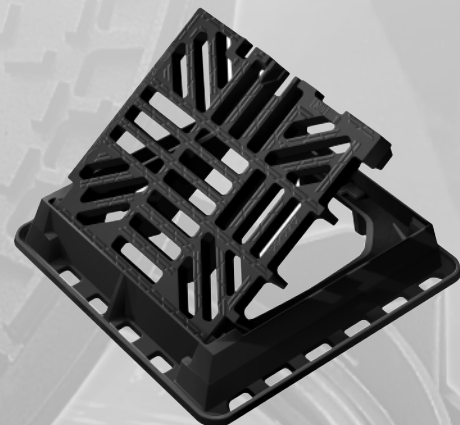

Gully gratings

and Surface Boxes



2011

General contents

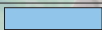
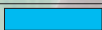
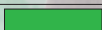
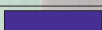
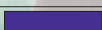
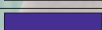
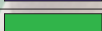
		Pages
Key benefits		4/5
Selection criteria for manhole covers		6/7
Manhole covers - contents		8
Installation guide for manhole covers and gratings		28/29
Telecom covers and sealed covers		30/32
Tree gratings		33
Gully gratings - contents		34
Selection criteria for gratings		35/36
Surface Boxes		54/55



International Product
specification guide



T-MAX guide



PAMETIC 2 guide



LINEASLOT guide



Installation guide



Key benefits

DUCTILE IRON

For more than 40 years, the **PAM** Municipal Casting ranges have been drawing benefit from the unmatched qualities of ductile iron : impact strength, resistance to specific mechanical stresses, high breaking strength and very high safety factors.

Thanks to the knowledge built up over many years in design and castings techniques, **PAM**'s latest generations of gratings and manhole covers have been designed with new performances.

The elasticity of ductile iron allows the linking and locking of AUTOLINEA and SQUADRA gratings and the SELECTA gully unit as well as the automatic locking of the new REXESS carriageway manhole cover, without the use of accessories.

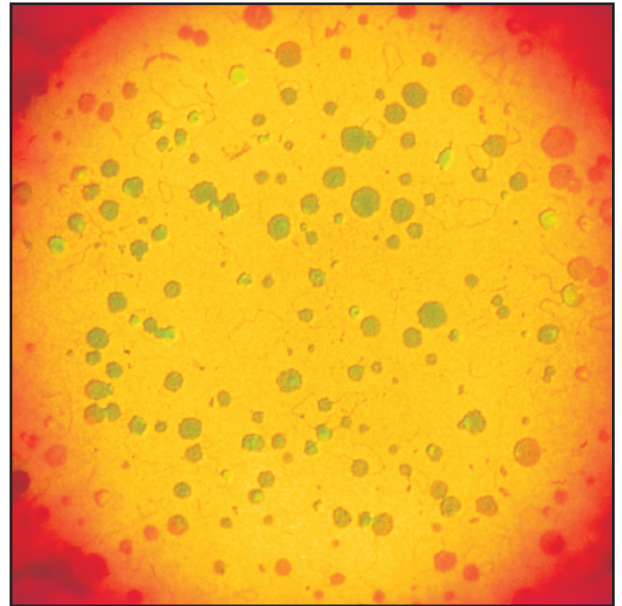

In ductile iron, the graphite particles, which look like small spheres, provide high tensile strength eliminating any risk of cracking.

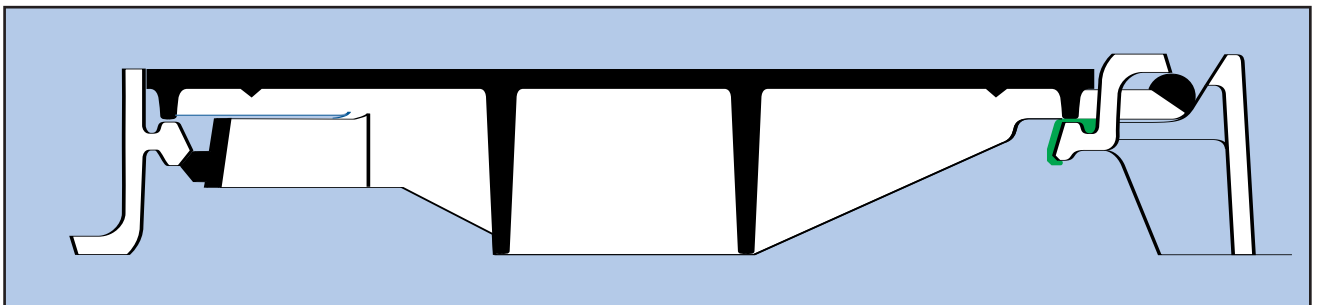

REXESS : the spring bar, integrated in the cover, allows automatic locking of the REXESS cover without accessories.

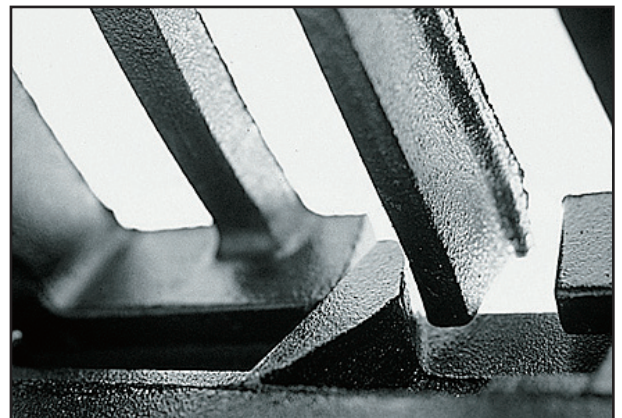
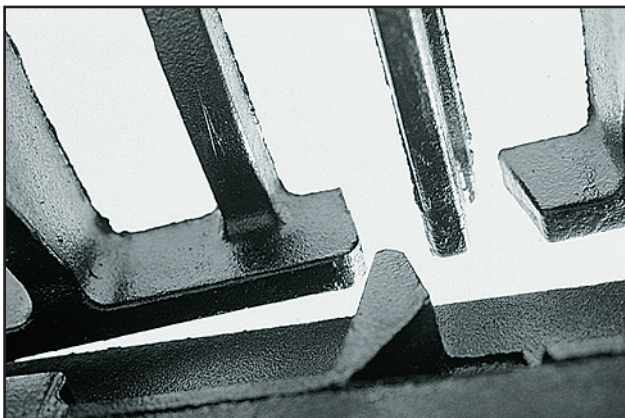

The spring-lock device guarantees:

- Stable seating in the frame
- Complete silence when trafficked
- Secure locking

ELASTOMERS

Manufacturer of sewer mains renowned for tight sealing, **PAM** has built up outstanding mastery in the field of elastomer and composite materials.

For some 20 years, **PAM** has chosen to apply this skill to municipal castings. Thus, **PAM** has developed two types of rings: elastomer and composite.

The quality of both rings used and their specific design ensure perfect stability of covers, safety for traffic and complete silence. And for many years, the elastomer rings are tested by the passing of several million vehicles.

The new composite rings, composed of a mixture polyethylene-polypropylene, show great performances in terms of fatigue strength and abrasion resistance.

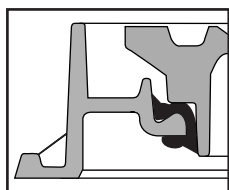

SERVICE

Through Head Offices, its sales network in France and everywhere throughout the world, **PAM** and engineering teams are responsive to customer requirements and offer advice and training.

Quick deliveries are ensured by efficient logistics based on a stock of 200.000 items.

A close-knit network of stockists and distributors ensures that all ranges are available on all European markets and promotes the **PAM** image of quality and service.

What you need to know about the EN 124 standard, certification, and quality...

• **Euronorm EN 124 *** : is a standard approved by CEN in Brussels relating to municipal castings, which has been adopted in all European countries. Under this, compulsory certification must be carried out by a third-party body. Its logo is mandatory cast on both cover/grate and frame.

• **The NF Quality mark *** : for municipal castings was introduced by AFNOR (French standards authority). Products bearing the **NF** stamp meet the specifications of EN 124, as well as additional quality criteria. The credibility of this approval is backed by the renown and expertise of the inspection and verification testing houses acting on behalf of AFNOR.

The following information is supplied in compliance with Article 10 of the French Decree dated 30 March 1995 concerning the certification of industrial products:

- The **NF** mark for municipal castings certifies that compliance with Regulation NF-110 and the manufacturer's specifications via continuous inspection procedures carried out by AFNOR.
- The following table lists the main certified specifications. For all figures please refer to the relevant paragraph EN 124 or to the regulations.

Caractéristiques	§ de EN 124	B125	C250	D400	E600	F900
Ventilation area	7,2	•	•	•	•	•
Clear opening	7,3	•	•	•	•	•
Depth of insertion	7,4	•	•	•	•	•
Cover/frame securing	7,8	•	•	•	•	•
Frame bearing area	7,15	•	•	•	•	•
Frame depth	7,16	•	•	•	•	•
Opening angle	7,17	•	•	•	•	•
Waterway area	7,9	•	•	•	•	•
Test load	8,3,2	•	•	•	•	•
Material	NF Mark rules	•	•	•	•	•
Trap seal depth	NF Mark rules	•	•	•	•	•
Road trials	NF Mark rules	•	•	•	•	•
Access for disabled people	NF Mark rules	•	•	•	•	•
Gratings & Gully gratings slip resistance	NF Mark rules	•	•	•	•	•

Study of design files of hinges, locking devices & gaskets

• AFNOR-Certification - 11, avenue Francis de Pressensé - 93571 Saint-Denis la Plaine Cedex

*Extract from AFNOR 1999 brochure.



The **NF** mark for municipal Castings guarantees a complete Quality Assurance Management covering all stages of production,



The **NF** mark for municipal Castings guarantees that strict product safety and performance have been carried out,



The **NF** mark for municipal Castings guarantees product tracability and origin,



The **NF** mark for municipal Castings guarantees customer service,



The **NF** mark for municipal Castings guarantees clear and precise information.

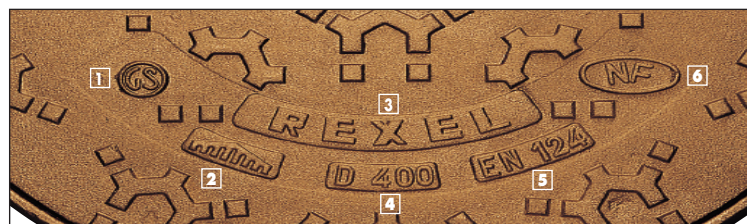

In compliance with EN 124, all products bearing the **NF** mark for municipal castings must also bear the following markings:

- 2** : Manufacturer identification
 - 4** : Resistance class
 - 5** : Reference standard
 - 6** : Mark of approval of the certification third-party body
- Additional markings:
- 1 : Ductile iron quality marking
 - 3 : Product identification

Selection criteria for manhole covers

PLACES OF INSTALLATION

Standard EN 124 divides products into minimum level groups and classes according to their intended place of installation :

- **Group 6 : (class F 900) :** Areas imposing particularly high wheel loads, such as aircraft pavements, etc..
- **Group 5 : (class E 600 mini) :** Areas imposing high wheel loads, such as docks, port areas, aircraft pavements, airports, factory yards, etc..
- **Group 4 : (class D 400 mini) :** Carriageways of roads - including pedestrian streets, hard shoulders and parking areas for all types of road vehicles.
- **Group 3 : (class C 250 mini) :** For gully tops installed in the area of kerbside channels of roads which, when measured from the kerb edge, extend to a maximum of 0.50 m into the carriageway and a maximum of 0.20 m into the footway.
- **Group 2 : (class B 125 mini) :** Footways, pedestrian areas and comparable areas, car parks and car parking decks.

Some manhole covers are capable of passing a test load which exceeds that specified for their class. Others are fitted with a reinforced frame in order to ensure stability in especially severe traffic conditions, while remaining in compliance with the installation conditions considered in the standard.

TRAFFIC STRESSES

In addition to the group and class concepts specified in EN 124, it is recommended that specific traffic and operating stresses should also be taken into account in order to select the most suitable product.

The following three parameters :

- number of vehicles,
 - speed,
 - type of vehicles - *cars or heavy vehicles* using the carriageway,
- are combined and contribute to the definition of the concept of the type of traffic.



TYPE OF TRAFFIC	NUMBER OF VEHICLES	SPEED	TYPE OF VEHICLES
Intense	High	Speed authorized on large urban roads	Regular use by heavy vehicles
Normal	Irregular	Stabilized urban speed	- Essentially light vehicles - Transit of heavy vehicles
Low	Low	Limited speed	Occasional truck traffic (deliveries, etc.)

PAM designs its manhole covers in accordance with traffic stresses in terms of : **stability, safety and silence**. The type of technical solutions implemented depends on the intended use of the casting.

TYPE OF TRAFFIC	SECURING OF COVER / GRATING IN FRAME	STABILITY / BEARING	INSERTION DEPTH (I)	FRAME DEPTH (F)
Intense	Weight of cover	Elastomer ring	$I \geq 80$ mm	$F = 100$ mm
Normal	- Locking - Metal seating	PE ring	Locking or $I \geq 50$ mm	$F = 100$ mm or $F = 75$ mm with anchoring means

NOTE : Standard EN 124 specifies that, where there is any doubt on the class to be used, the higher class must be selected.

Selection criteria for manhole covers

OPERATING STRESSES

Efficient management of sewer systems requires more frequent inspections and checks. The handling of municipal castings designed without due care can lead to damage in the lumbar region of the back and spine. All **PAM** manhole covers are designed to facilitate opening and closing operations with a minimum of force and to provide service teams with more ergonomic working conditions.

INSPECTIONS	OPENING ASSISTANCE SYSTEM	USER SAFETY	OPENING ERGONOMICS
Frequent	Hinge	90° locking Opening to 130°	1 single movement Standing position
Periodic	- Hinged mechanism - Pins	Device ensuring holding of tool and guidance of cover	Handling in two steps
Occasional	None	Cover positioning marker	Bending of back and pulling / lifting effort

RANGE

PAM offers a very wide range of carriageway manhole covers in accordance with all the requirements of standards and satisfying the specific criteria of each place of installation.

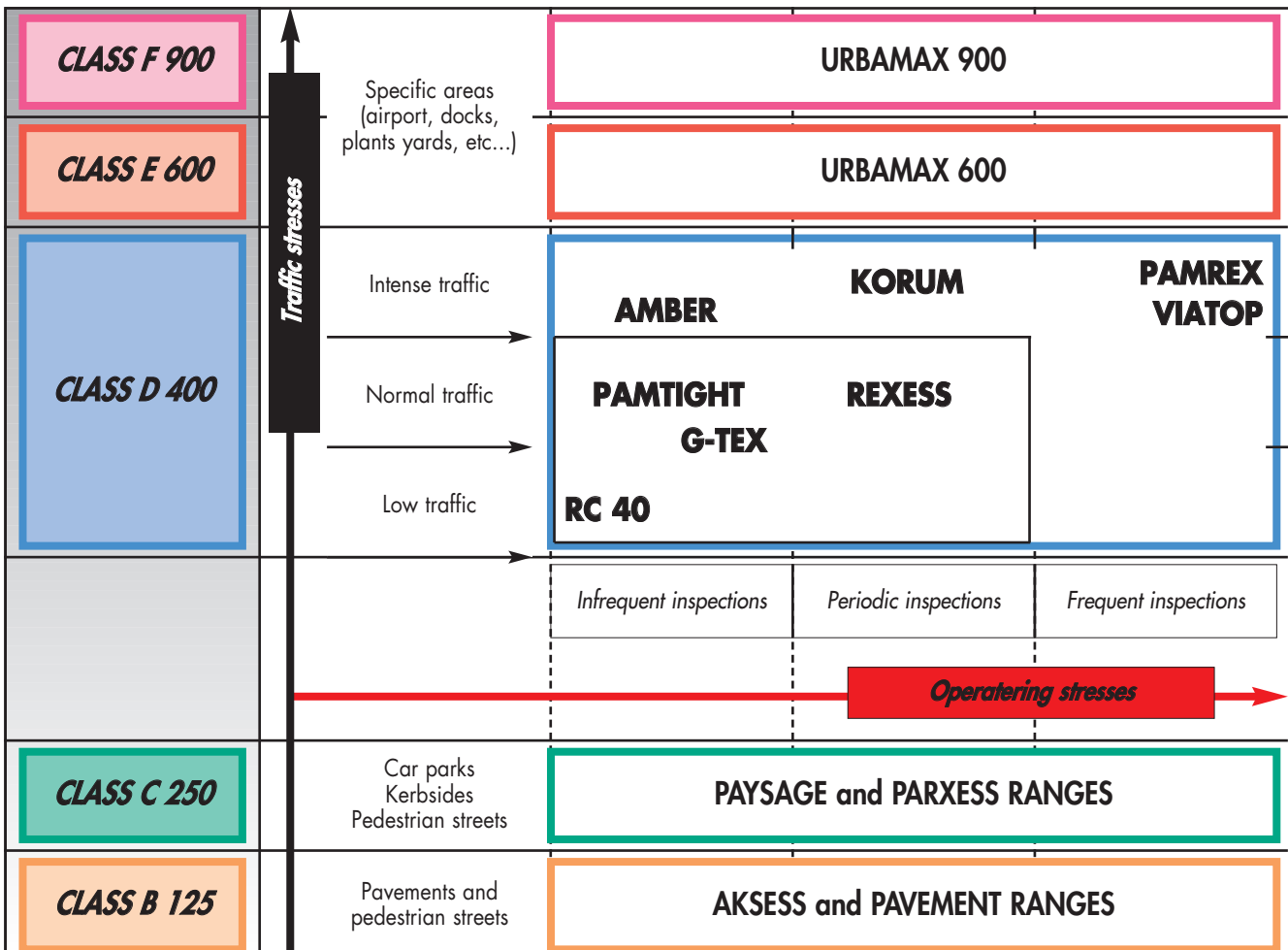

Manhole covers - contents

	Pages
URBAMAX	9
PAMREX	10/11
PAMREX 700, PAMREX 800	12
VIATOP - AMBER	13
PAMTIGHT INTER-AX2	14
KORUM	15
REXESS	16/17
G-TEX - RC 40	18
Various manhole covers	19
Manhole covers for pavement and car parks - PARXESS	20/21
AKSESS covers	22/23
Pavement covers - OPTEA	24/25



Heavy traffic

- Ductile iron
- Class E 600 / F 900
- Elastomer ring
- Push-in central pad
- Sealed handling box
- EN 124  

HIGH STRENGTH



URBAMAX E 600



URBAMAX F 900

Designed to withstand all types of traffic, URBAMAX can be installed on roads subjected to super heavy duty loading in addition to airports and dock areas, etc..

STRENGTH ++++

URBAMAX, class E 600 and F 900, has a high tensile strength.

STABILITY +++



The weight of the cover (63 kg in the non-ventilated version) and the addition of an elastomer ring and a double skirt dampens vibrations caused by traffic, ensuring total stability.

OPERATION ++

A handling box allows URBAMAX to be handled with traditional site tools : such as a pointed or flat end pick-axe, or crowbar. The cover is specially designed to ease closing.

	Type	Frame	Reference	Mass (kg)		Dimensions (mm)	
				Total	Cover	Clear opening	Frame depth
Class F 900	Non-ventilated	round	CFUR60AF	93	63	600	100
		square	CFUR60KF	105			
	Ventilated	round	CFUR60BF	88	61.5		
		square	CFUR60LF	97			
Class E 600	Non-ventilated	round	CEUR60AF	93	62	600	100
		square	CEUR60KF	102			
	Ventilated	round	CEUR60BF	86	60.5		
		square	CEUR60LF	95			

PAMREX

- Ductile iron
 - Class D400
 - Hinged
 - Elastomer ring
 - Sealed handling box
 - Optional anti-theft cover lock
 - Lifting rings integral with the frame
- EN 124  

ERGONOMICS ++++

HANDLING BOX

Raising the PAMREX cover to make a visual inspection while standing is effortless: place a crow-bar at 35° in the brand handling box insertion point and nothing could be easier. Conventional means of opening are also possible.



Heavy traffic

HIGH RESISTANCE TO TRAFFIC, ENHANCED ERGONOMIC DESIGN

Designed to cope with the heaviest traffic but quiet thanks to its elastomer seal, PAMREX is a reliable manhole that has withstood the test of time.

PAMREX's enhanced ergonomics now make it even easier to carry out works on systems while also improving operator safety.

In hundreds of towns and cities, even after millions of vehicles have driven over it, PAMREX continues to demonstrate its qualities of endurance and reliability.

STRENGTH ++++

PAMREX has a high safety factor with a breaking strength margin well above the requirements of EN 124.

Designed to withstand the stresses of intense traffic, in terms of large numbers of vehicles, regular use by very heavy vehicles and high speeds, PAMREX is the absolute reference in terms of performance and durability in France and Europe.

STABILITY ++++

PAMREX is silent: there is no metal-to-metal contact. Its frame is fitted with an elastomer ring which ensures:

- Damping of mechanical stresses caused by the repeated passage of vehicles,
- Self-centering and stability of the cover: the ring pinches the lower skirt and works against the suction phenomenon caused by vehicles' tyres.

OPERATION ++++

The PAMREX hinge ensures easy opening and operating safety:

- The PAMREX hinge does not come into contact with the frame when the cover is closed and it is, therefore, not subjected to traffic stresses. It is only placed under stress during opening and closing operations,
- In the event of the sewer system being accidentally pressurized, the PAMREX cover opens without coming out of its housing and recloses under its own weight.

PAMREX

The "extras that make life easier"

Option of fitting an anti-theft system



Safety / Operation identification

Identification of frame shape from markings, visible after embedment

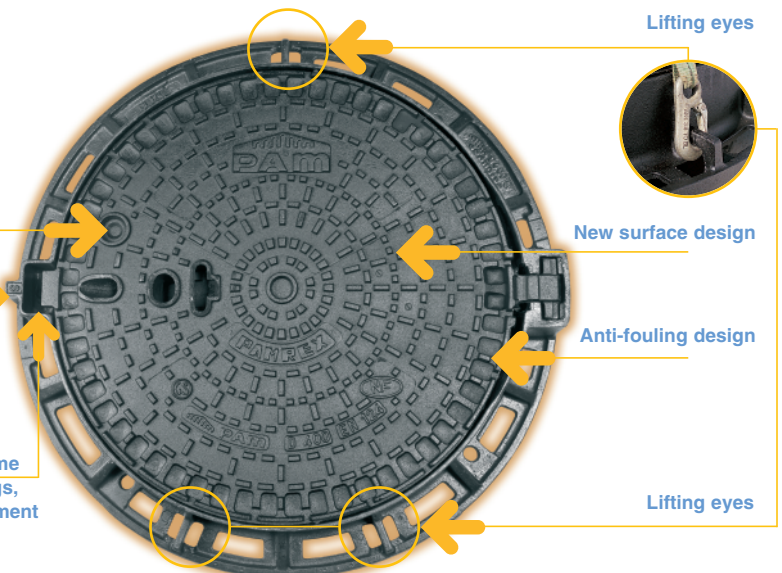



Easy installation



A manhole cover designed to match perfectly into its environment.



THE PAMREX RANGE



PAMREX SAFETY

Opens to 130°, blocks at 90° when closing
 ➔ for sewage pipeworks



PAMREX OPERATION

Opens to 130°, without blocking at 90° when closing
 ➔ for pipeworks inspection from road surface



PAMREX SAFETY WITH CONCRETE INFILLED COVER

Opens to 130°, blocks at 90° when closing
 ➔ for sewage pipeworks
 ➔ cover appearance matches paved surrounding areas
 ➔ operation conditions identical to any other PAMREX versions

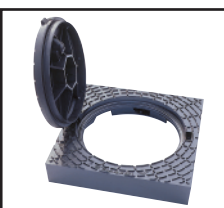

PAMREX WITH APPARENT FRAME

Frame designed for easy cobbles and paving installation, (height= 160 mm)
 ➔ for paved and pedestrian streets

Type	Type of frame	Reference	Mass (in kg)		Dimensions mm	
			Total	Cover	Clear opening	Frame depth
Non-ventilated	Round	CDPA60EF	88	55	610	100
Non-ventilated	Square	CDPA60MF	97	55	610	100
ventilated	Round	CDPA60FF	87	54	610	100
ventilated	Square	CDPA60PF	96	54	610	100

Type	Type of frame	Reference	Mass (in kg)		Dimensions mm	
			Total	Cover	Clear opening	Frame depth
Non-ventilated	Round	CDPA60AF	88	55	610	100
Non-ventilated	Square	CDPA60KF	97	55	610	100
ventilated	Round	CDPA60BF	87	54	610	100
ventilated	Square	CDPA60LF	96	54	610	100

Type	Type of frame	Reference	Mass (in kg)		Dimensions mm	
			Total	Cover	Clear opening	Frame depth
Non-ventilated	Round	CDPA60GL	108	75	610	100
Non-ventilated	Square	CDPA60WF	117	75	610	100

Type	Type of frame	Reference	Mass (in kg)		Dimensions mm	
			Total	Cover	Clear opening	Frame depth
Safety						
Non-ventilated	apparent	CDPA603F	132	55	610	160
ventilated	apparent	CDPA604F	131	54	610	160

- The PAMREX grating is interchangeable with any cover of PAMREX 600 series
- The PAMREX grating is interchangeable with the cover. (see page 37)
- Special versions of PAMREX fitted with a water-tightness plug are also available. Please consult us.
- PAMREX accessories, see page 19.

Wide clear-opening manhole covers

PAMREX 700 Safety

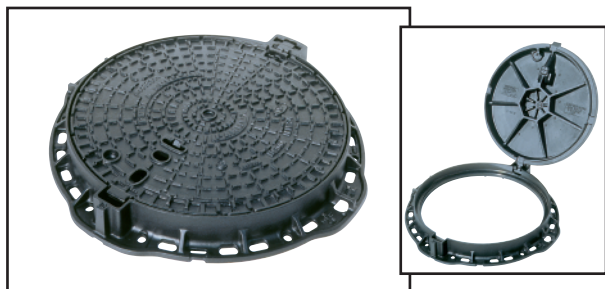

Heavy traffic

- Ductile iron
- Class D400
- Hinged
- Clear opening: 700 mm
- Elastomer ring
- Sealed handling box
- Optional anti-theft cover lock
- Lifting rings integral with frame
- EN 124 

PAMREX 700 has the same functional features as PAMREX 600 (see pages 10 and 11). Access is made through a wide 700-mm opening specifically designed for systems requiring special safety conditions for operators.

Type	Type of frame	Reference	Mass (in kg)		Dimensions mm	
			Total	Cover	Clear opening	Frame depth
Non-ventilated	Round	CDPA70EF	108	71	700	100
Non-ventilated	Square	CDPA70MF	118	71	700	100
Ventilated	Round	CDPA70FF	108	71	700	100
Ventilated	Square	CDPA70PF	118	71	700	100

PAMREX 800 Safety

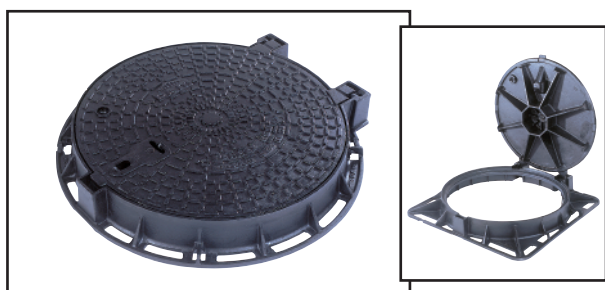

- Ductile iron
- Class D 400
- Clear opening : 800 mm
- Opens to 130°, blocks at 90° when closing
- Elastomer ring
- Sealed handling box
- Optional anti-theft cover lock
- Lifting rings integral with frame
- EN 124 

- Pamrex 800 provides easy opening, while continuing to offer the high performance levels of the successful Pamrex 600 mm and 700 mm clear opening designs.
- The 800 mm clear opening enables maintenance personnel to enter the manhole with their safety equipment, or to lower bulky equipment into the below ground network.

Type	Type of frame	Reference	Mass (in kg)		Dimensions mm	
			Total	Cover	Clear opening	Frame depth
Non-ventilated	Round	CDPA80EF	121	73	800	125
Non-ventilated	Square	CDPA80MF	131	73	800	125
ventilated	Round	CDPA80FF	121	72	800	125
ventilated	Square	CDPA80PF	131	72	800	125

PAMREX 800 Safety with opening assisted - closing with SCS locking kit (key not-provided)



This version has the same features as the PAMREX 800 standard version. The lifting effort and the stresses transmitted to the chamber are reduced with its assistance stainless steel gas arm. This product is systematically fitted with a SCS locking system.



Type	Type of frame	Reference	Mass (in kg)		Dimensions mm	
			Total	Cover	Clear opening	Frame depth
Non-ventilated	Round	CDPA80EFX37	121	73	800	125
Non-ventilated	Square	CDPA80MFX37	131	73	800	125
ventilated	Round	CDPA80FFX37	121	73	800	125
ventilated	Square	CDPA80PFX37	131	73	800	125

- PAMREX accessories, see page 19.
- PAMREX 900 available on request.

VIATOP NIVEAU



Heavy traffic

- Ductile iron manhole cover
- Hinged with 90° Blocking
- Class D400
- Height adjustable
- Elastomer noise damper ring.
- Clear opening: 610 mm or 700 mm
- EN 124  

- Cover always perfectly lined up with the surface of the carriage way after compacting.
- No load applied directly on the concrete chamber.

VIATOP NIVEAU 600 H 200

Type	Type of frame	Reference	Mass (in kg)		Dimensions mm			Concrete Infilled Cover
			Total	Cover	Clear opening	Frame overall	Frame depth	
Ventilated	Round	CDVT60RG	98	49	610	815	200	
Non-ventilated	Round	CDVT60QG	99	51	610	815	200	
Ventilated	Round	CDVT60TG	122	72	610	815	200	x
Non-ventilated	Round	CDVT60SG	123	73	610	815	200	x

VIATOP NIVEAU 600 H 140

Ventilated	Round	CDVT60RGX40	83	49	610	815	140
Non-ventilated	Round	CDVT60QGX40	84	51	610	815	140

VIATOP NIVEAU 700 H 200

Ventilated	Round	CDVT70RU	122	71	725	930	200
Non-ventilated	Round	CDVT70QU	122	71	725	930	200

AMBER



Heavy traffic

- Ductile iron
- Automatic locking by ductile iron spring bar
- Concrete filled cover
- Pull and slide concept
- Class D400
- EN 124  



Type	Type of frame	Reference	Mass (in kg)		Dimensions mm		
			Total	Cover	Frame overall	Clear opening	Frame depth
Ventilated	Round	CDAM60DW	69.5	48.5	785	608	104
Non-ventilated	Round	CDAM60CW	70.0	49.0	785	608	104

STEEL MUDPAN

Model	References
STEEL MUDPAN FOR VIATOP NIVEAU 600	C4
STEEL MUDPAN FOR VIATOP NIVEAU 700	C2
STEEL MUDPAN FOR AMBER	185418

PAMTIGHT

Normal traffic

- Ductile iron
Class D 400
- Two rings : - polyethylene seating ring
- elastomer sealing ring
- Fastened by 6 bolts and clamping claws
- Sealed handling box
- EN 124  

STRENGTH +++

By design, PAMTIGHT combines resistance to traffic stresses and tight sealing.

STABILITY +++

The cover is fastened by six clamping claws held by stainless steel bolts. Provision should also be made for anchoring the frame to the cover of the shaft in addition to ensuring the bedding is sealed.

OPERATION +

The clamping device can be rotated and the cover opened simply by loosening the bolts. Easy handling is facilitated by the relative low cover weight (52.5 kg) and the presence of a handling box (sealed).

HIGH-PERFORMANCE SEALING

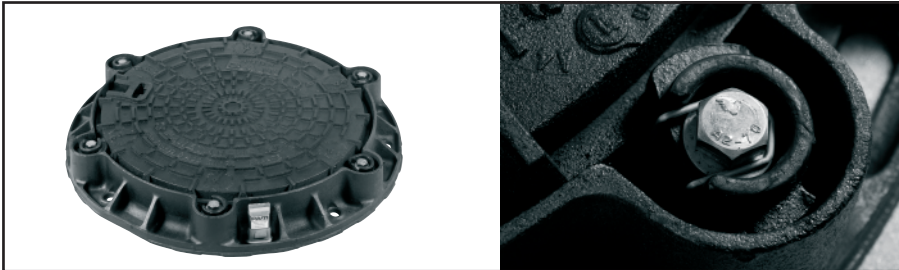

PAMTIGHT is sealed to prevent the ingress or escape of water to a 1 bar positive or negative pressure rating.



Type	Frame	Reference	Mass (in kg)		Dimensions mm	
			Total	Cover	Clear opening	Frame depth
Non-ventilated	Round	CDPE60AA	102	52.5	610	100

Important

The kit Trafex (Reference : C49) was developed to improve the exploitation of the manhole cover Pamtight in conditions of extreme service : under strong and violent vibrations from traffic or as result of handling operation and maintenance carried out without the necessary precautions. It consists of anti-rotation clips, clamps, screws and washers as well as detailed notices. Its installation is the responsibility of the usual sanitation teams' services or road ones, according to the comments they have made on the site. In case of doubt as to its use, contact your Regional sales office of **PAM**. The manhole cover Pamtight is now offered for sale equipped with the kit Trafex.

INTER-AX2

Normal traffic

- Ductile iron
Class D 400
- 2 triangular half covers
- Widened-angles frame
- Square clear opening : 600 x 600 mm
- Metal seating
- EN 124  





Non-rock 3-point suspension on each cover.

Type	Frame	Reference	Mass (in kg)		Dimensions mm	
			Total	Cover	Clear opening	Frame depth
Non ventilated	Square	185 893	74.3	2 x 30	600 x 600	100

- Please consult our second catalogue to discover the range of square opening manhole covers

Heavy traffic

- Ductile iron
- Class D 400
- Hinged
- Composite ring
- Sealed handling box
- Spring bar
- Optional anti-theft spline / Optional anti-intrusion lock
- EN 124  



ERGONOMICS ++++

Safe and effortless handling thanks to the ball-joint hinge.
Effortless unlocking and opening of cover with pickaxe point

STRENGTH : ++++

New frame and ribs design prevent the deformation of the KORUM under intense traffic conditions

OPERATION : ++++

The hinge blocks at 90° when closing and ensures operating safety..

STABILITY : ++++

The spring locking mechanism under constant tension locks the KORUM cover in place in its frame in complete safety.

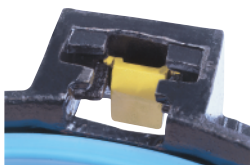

Ductile iron anti-theft spline

Prevent the cover from being extracted and stolen. It can be installed after the bedding of the frame.

Note: accessories are yellow painted for illustration purpose



Anti-intrusion lock :

The new locks D50, features a ductile cast iron bar, with high resistance to vandalism attempts.

Type	Type of frame	Spline	Lock type D50	Reference	Mass (in kg)		Dimensions mm	
					Total	Cover	Clear opening	Frame depth
Non ventilated	round	no	no	CDKO60EF	62	38	606	104
Non ventilated	square	no	no	CDKO60MF	69	38	606	104
ventilated	round	no	no	CDKO60FF	62	38	606	104
ventilated	square	no	no	CDKO60PF	69	38	606	104
Non ventilated	round	yes	no	CDKO60EFX17	62	38	606	104
Non ventilated	square	yes	no	CDKO60MFX17	69	38	606	104
ventilated	round	yes	no	CDKO60FFX17	62	38	606	104
ventilated	square	yes	no	CDKO60PFX17	69	38	606	104
Non ventilated	round	no	yes	CDKO60EFX15*	62	38	606	104
Non ventilated	square	no	yes	CDKO60MFX15*	69	38	606	104
ventilated	round	no	yes	CDKO60FFX15*	62	38	606	104
ventilated	square	no	yes	CDKO60PFX15*	69	38	606	104
Non ventilated	round	yes	yes	CDKO60EFX31*	62	38	606	104
Non ventilated	square	yes	yes	CDKO60MFX31*	69	38	606	104
ventilated	round	yes	yes	CDKO60FFX31*	62	38	606	104
ventilated	square	yes	yes	CDKO60PFX31*	69	38	606	104

* for the locked version, please ordered the locking key (ref: C46) separately

KIT D50 FOR KORUM

Model	Reference
Kit without handling key	C47
Handling key	C46

ANTI-THEFT SPLINE

Model	Reference
Anti-theft spline	170900
Kit of 10 splines	C59

Normal traffic

New access cover in class D400

- Ductile iron
Class D 400
Automatic locking by ductile iron spring bar
Hinged cover with 90° safety blocking
Optional anti-theft spline and locking system
Composite seating ring

EN124

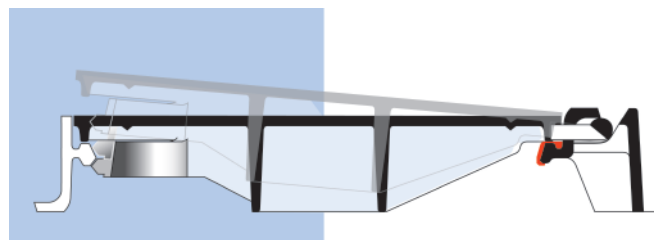
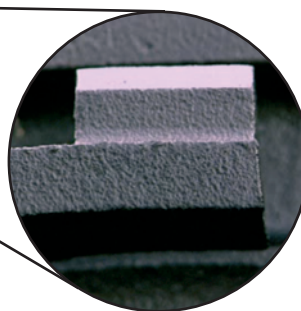

Performance enhancement Composite vs PE ring:

- Resistance under traffic: x 2.6
- Resistance to breaking: + 70%
- Resistance to abrasion: x 3

- Stability and safety under traffic ensured by ductile iron spring bar.
- Automatic system secure and stable.

THE BEST OF EXPERIENCE

Representing a new generation of carriageways manhole covers, REXESS combines the innovation of its spring locking mechanism requiring no accessories with easy opening, stability, safety and silence.

STRENGTH ++

The completely new design of REXESS gives a double guarantee of performance and long service life. Optimized geometry of the cover: rigidity and strength to withstand the stress of usual carriageway's traffic. Fully mastered frame profiles: perfect seating on shafts, effective and durable bedding.

STABILITY ++

The spring locking mechanism provides REXESS with remarkable dynamic stability:
3 contact points: the hinge, the locking mechanism and the ring ensure vertical stability of the cover in the frame.
Permanent contact between the locking mechanism and the cover positioning lugs ensure horizontal stability.
The locking mechanism keeps the cover held against the sound-proofing ring: the cover is prevented from rocking and complete silence is ensured.

OPERATION ++

- Easy opening: using suggested tools, a lever effect in the handling box frees the spring locking mechanism and releases the manhole cover.
- Easy lifting once unlocked: the hinge reduces the force required to open the cover by half. For completely ergonomic handling, the central pad in the cover can be pushed in, and reclosed using the special plug (optional).
- Easy locking when closing: the cover can be locked without requiring any accessories, by simply pressing with the foot. If it is left unlocked, REXESS is locked automatically as soon as the first vehicle crossed it.

Normal traffic

PROTECTION OF THE OPERATORS

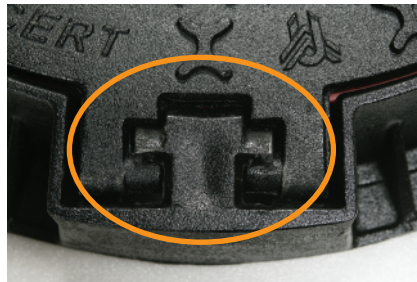
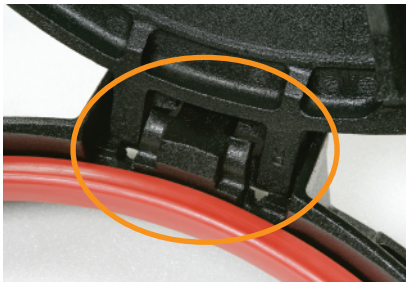

THE REXESS RANGE



Round frame Ø 785	Reference	Mass (in kg)		Dimensions mm	
		Total	Cover	Clear opening	Frame depth
Non-ventilated	CDRK60FYX44	54.3	31.5	600	104
Ventilated	CDRK60EYX44	54.3	31.5		



Round frame Ø 900	Reference	Mass (in kg)		Dimensions mm	
		Total	Cover	Clear opening	Frame depth
Non-ventilated	CDRK60FY	55.8	31.5	600	104
Ventilated	CDRK60EY	55.8	31.5		



Square frame Ø 850	Reference	Mass (in kg)		Dimensions mm	
		Total	Cover	Clear opening	Frame depth
Non-ventilated	CDRK60MY	65.0	31.5	600	100
Ventilated	CDRK60PY	65.0	31.5		

ANTI-THEFT SPLINE FOR REXESS, REXEL AND REXEL GRATING

The hinge of the cover has been designed to receive an anti-theft spline. It blocks the extraction of the cover. Beware: The anti-theft spline disables the 90° blocking function.



ANTI-THEFT SPLINE

Model	Reference
Kit of 10 splines	C82
Box of 132 splines	C81

LOCKING KITS FOR REXESS, REXEL, G-TEX AND REXEL GRATING

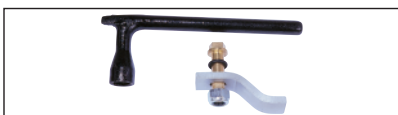

KIT "PENTA"

Locking clip in stainless steel

Model	Reference
Kit without handling key	C10

KIT "PENTA" Plus

Locking clip in ductile iron

Model	Reference
Kit without handling key	C54

Handling key	C17
--------------	-----

KIT "SCS"

Locking clip in stainless steel

Model	Reference
Kit without handling key	C12

KIT "SCS" Plus



Locking clip in ductile iron

Model	Reference
Kit without handling key	C101

Handling key	C18
--------------	-----

G-TEX

Low traffic

- Ductile iron
Class D 400
Automatic locking by ductile iron spring bar
Pull and slide concept
Polyethylene ring
Optional anti-intrusion lock
EN124  

STRENGTH ++

The G-TEX safety factor compared to EN124 requirements intends it for moderate traffic areas.

STABILITY ++

G-TEX offers a safe and stable automatic locking system combined with a polyethylene ring.

OPERATION ++

Unlocking, removal and reinstallation of the cover are carried out using a simple pickaxe, risk-free of pinching.

G-TEX RANGE





Type	Type of frame	Reference	Mass (in kg)		Dimensions mm	
			Total	Cover	Clear opening	Frame depth
Non-ventilated	Round	CDGX60AF	56.7	33.5	600	100
Ventilated	Round	CDGX60BF	56.7	33.5		
Non-ventilated	Square	CDGX60KF	63	33.5	600	100
Ventilated	Square	CDGX60LF	63	33.5		

Locking kits, see page 17

RC 40

Low traffic

- Ductile iron + concrete
Class D 400
Supplied with concrete infill
Polyethylene ring
Sealed handling box
EN 124  

Lightweight concrete infilled manhole cover suitable for areas with low traffic density.



Type	Frame	Reference	Mass (in kg)		Dimensions mm	
			Total	Cover	Clear opening	Frame depth
Non-ventilated	Round	CDRC60CF	78	59.5	600	75
	Square	CDRC40KF	84,5			

NB: The frames are supplied with grouting holes in compliance with EN124 functional requirements.

Accessories for all PAMREX manholes and gratings ranges

LOCKING KITS



Locking clip, PENTA or SCS bolt

- 1/4 turn lock actuated by an asymmetrical five-sided bolt head (PENTA) or unique notched cylindrical head (SCS).
 - On site installation takes 5 minute:
 - ➔ Punch out the centre of the locking bolt area.
 - ➔ Install the kit in compliance with the instructions supplied.
 - Lock must be operated with the handling key supplied separately.
- It is recommended not to use the SCS key to open the cover.



1/4 turn lock system



PENTA Plus or SCS Plus bolt

■ KITS PENTA FOR PAMREX 600, 700 AND 800

PENTA, locking clip in stainless steel

DN	Model	Reference
600		
700	kit without handling key Penta	C6
800	kit without handling key Penta	C14

PENTA Plus, locking clip in ductile iron

DN	Model	Reference
600		
700	kit without handling key Penta	C56
800	kit without handling key Penta	C76
	Handling key PENTA	C17

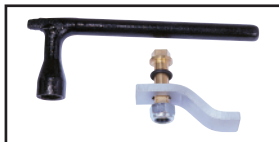

PENTA bolt and key

■ KITS SCS FOR PAMREX 600, 700 AND 800

SCS, locking clip in stainless steel

DN	Model	Reference
600		
700	kit without handling key SCS	C8
800	kit without handling key SCS	C16

SCS Plus, locking clip in ductile iron

DN	Model	Reference
600		
700	kit without handling key SCS	C58
800	kit without handling key SCS	C78
	Handling key SCS	C18



SCS bolt and key

GALVANISED STEEL MUDPAN FOR PAMREX



- Designed for ventilated covers and grating
- 4 suspension legs rest on elastomer ring
- High resistance to load of sand and mud
- Mudpans do not impair manhole covers or gratings normal functioning



Model	References
STEEL MUDPAN FOR COVER AND GRATING PAMREX 600	C1
STEEL MUDPAN FOR PAMREX 700	C2
STEEL MUDPAN FOR PAMREX 800	C3

INSPECTION MANHOLE STEPS

■ DUCTILE IRON

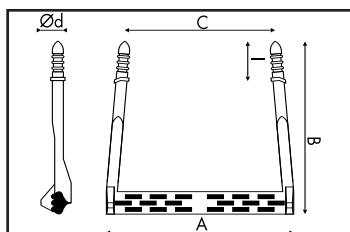
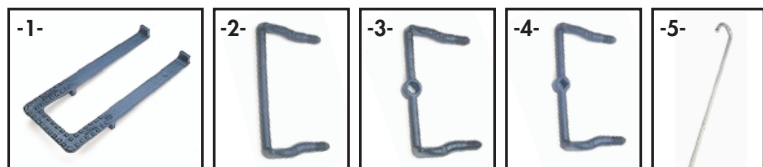

Type	Reference	Dimensions mm					Mass in kg
		d	C	B	I	A	
1/ BS1247 galvanized	C25		153	365	60	153	2
2/ Standard	C26	25	300	200	60	350	2.4
3/ with handbar cross	C27	25	300	200	60	350	2.5
4/ with handbar holder	C28	25	300	200	60	350	2.5
5/ handbar	C29	25				1200	5.3

*Complies with EN 124 functional requirements

Cover for traffic-bearing pedestrian zone

PARXESS

The new PARXESS hydraulic range is designed to provide an innovative, reliable and efficient response to new needs for access covers located in pavements and similar locations, where they may have to withstand the occasional load of passing vehicles. PARXESS offers the same benefits as AKSESS. (See p 22 and 23)



ERGONOMICS Convenient, easy opening and handling of cover

STABILITY New cover seatings system with improved dynamic cover location within the frame

STRENGTH Frames and covers are designed to provide rigidity, resistance to deflection and durability

EASY INSTALLATION Wide flanged frames give optimal seating and efficient, durable bedding on square concrete boxes

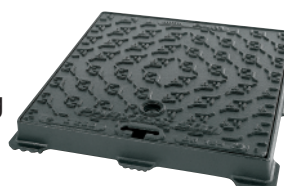
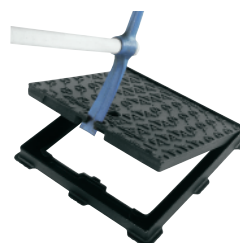

Identification of underground networks: four different caps are provided, each marked with a symbol representing an underground network, are available as an option.

- Plate of 4 identification caps: C42
- Locking kit without operating key: C41
- Operating key: C17



Reference	Mass (in kg)		Dimensions mm	
	Total	Cover	Clear opening	Frame depth
CBPK40HF	23.4	15.6	300	56
CBPK50HF	32	21.5	400	
CBPK60HF	39	31	500	
CBPK70HF	54	45.4	600	

PAYSAGE

- Ductile iron Class C 250
- Polyethylene ring
- Sealed handling box
- EN 124



The PAYSAGE C 250 manhole cover can be installed in parking areas, at roadsides, in kerbside channels or on pedestrian footways.



Type	Frame	Reference	Mass (in kg)		Dimensions mm	
			Total	Cover	Clear opening	Frame depth
Non-ventilated	Round	CCPY60RF	53	35	600	75
	Square	CCPY60CF	60			

HEIGHT ADJUSTABLE INSPECTION COVERS



Ductile iron
Class C 250
EN 124



These manhole covers are fitted on DN 400, DN 300 and DN 250 extensions installed on DN 300 and DN 250 inspection chambers. The hinged cover is tamper-proof once sealed. The cover, sliding inside synthetic ring, is height adjustable up to 95 mm. Tightness is obtained by means of a sealing ring (supplied) for either:

- cast iron DN 300/DN 250
- PVC DN 300/DN 250
- PVC DN 400

SQUARE FRAME



Box		Frame dimension	Shape		Reference	Mass in kg		Dimension mm	
Size	Material		Frame	Cover		Total	Cover	Clear opening	Adjustability
400	PVC	450	Square	Round	CCBR40BF	25	10	303	80
300	cast iron	360	Square	Round	CCBR30AF	18	6	225	95
	PVC				CCBR30BF				
250	cast iron	318	Square	Round	CCBR25AF	15	4	181	95
	PVC				CCBR25BF				

ROUND FRAME



Box		Frame dimension	Shape		Reference	Mass in kg		Dimension mm	
Size	Material		Frame	Cover		Total	Cover	Clear opening	Adjustability
400	PVC	460	Round	Round	CCBR40SFX27	25.2	8.7	303	80
300	cast iron	380	Round	Round	CCBR30SFX26	18	6	225	95
	PVC				CCBR30SFX27				
250	cast iron	330	Round	Round	CCBR25SFX26	14	4.3	181	95
	PVC				CCBR25SFX27				

AKSESS : pavement hydraulic manhole cover

AKSESS, FOLLOW THE STAR OF MANHOLE COVERS

- Ductile iron
Hydraulic manhole cover
Class B 125
EN 124

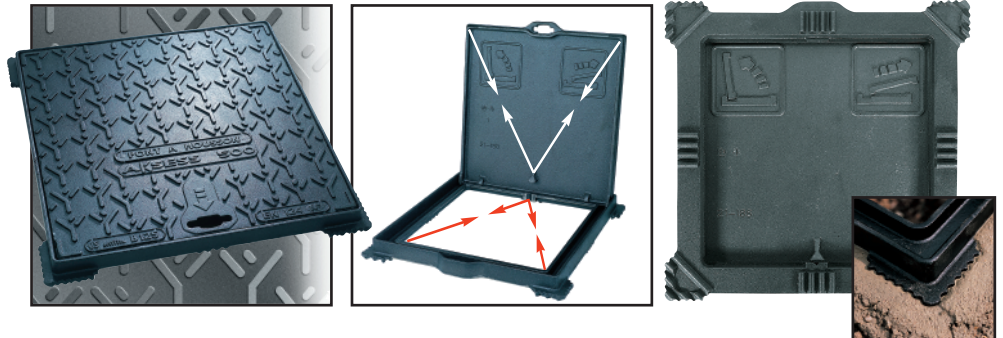

STABLE, QUIET AND STRONG

Thanks to their perfect stability, AKSESS (water) manhole covers ensure quiet, trouble-free use for pedestrians and residents alike.

- 3-point non-rock system ensures the cover remains firmly seated in its frame
- Rigid and stable frames incorporating the LTS® system
- The underside of the wide seating pads located at each corner of the frame have a unique corrugated design that improves embedment and increases resistance to lateral shear by up to 5 times more than conventional designs

APPEARANCE

AKSESS is a range of attractive and functional manhole covers for pavement applications featuring:

- A new dynamic non-skid surface pattern,
- A universal lifting point with integral usage indicator
- A specific diagram for the locked versions



standard Aksess

EASY OPERATION

AKSESS, the fast and ergonomic solution for access to networks installed under pavements

- Opens effortlessly and remains stable in the vertical position in its frame;
- Slides effortlessly for practical handling;
- The lifting point for non-locked AKSESS covers is ergonomic and designed for use with standard tools



LOCKED AKSESS COVERS

SECURITY AND THEFT DETERRENCE

The locked version of Aksess covers meets specific requirements for the prevention of theft, vandalism and intrusion

- Protection of appliances and equipment installed under pavements
- Deterrent against cover theft
- Locked AKSESS covers have a special opening that can only be operated using the AKSESS key, which operates the special 1/4-turn lock

Guaranteed protection of your equipment.



AKSESS : pavement hydraulic manhole cover

OPTIONAL NETWORK IDENTIFICATION

Specific AKSESS caps:

- Protect the locking system against the ingress of debris
- Identify the type of network installed under the pavement

The AKSESS caps symbolise four of the most common services for which manholes are used:

- Wastewater
- Storm water
- Water meters
- Lighting/Traffic lights

Each locked Aksess manhole cover is supplied with four identification caps.



STANDARD VERSION (NON LOCKED)

Type	Reference	Dimensions mm			Mass kg
		Outside of frame	Clear opening	Frame height	
AKSESS 300	CBAK30HF	310 x 310	220	37	8.2
AKSESS 400	CBAK40HF	410 x 410	300	37	12.8
AKSESS 450	CBAK45HF	460 x 460	350	38	15.3
AKSESS 500	CBAK50HF	510 x 510	400	38	18.2
AKSESS 550	CBAK55HF	550 x 580	450	38	22.0
AKSESS 550 x 700	CBAK75HF	560 x 710	450 x 600	38	32.0
AKSESS 600	CBAK60HF	610 x 610	500	38	29.4
AKSESS 700	CBAK70HF	720 x 720	600	38	38.8
AKSESS 800	CBAK80HF	820 x 820	700	41	52.7

LOCKED VERSION

Type	Reference	Dimensions mm			Mass kg
		Outside of frame	Clear opening	Frame height	
AKSESS 300	CBAK30HFX16	310 x 310	220	37	8.2
AKSESS 400	CBAK40HFX16	410 x 410	300	37	12.8
AKSESS 450	CBAK45HFX16	460 x 460	350	38	15,3
AKSESS 500	CBAK50HFX16	510 x 510	400	38	18.2
AKSESS 550	CBAK55HFX16	550 x 580	450	38	22.0
AKSESS 550 x 700	CBAK75HFX16	560 x 710	450 x 600	38	32.0
AKSESS 600	CBAK60HFX16	610 x 610	500	38	29.4
AKSESS 700	CBAK70HFX16	720 x 720	600	38	38.8
AKSESS 800	CBAK80HFX16	820 x 820	700	41	52.7



Type	Reference
Aksess handling key	C17

Locking with "SCS" solution : please consult

Other B125 Manhole covers

SQUARE HYDRAULIC MANHOLE COVERS

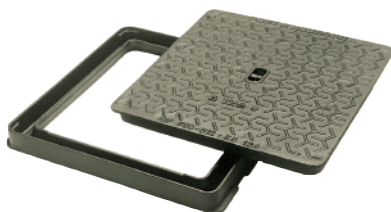

Dimensions of frame	Shape		Reference	Mass (in kg)		Dimensions mm	
	Frame	Cover		Total	Cover	Clear opening	Frame depth
300	CBHY30HF	8.1	5	233	29		
415	CBHY40HF	12.9	8,3	329	30		
520	CBHY50HF	26.5	15.5	404	48		
600	CBHY60HF	37.3	23	500	48.5		
700	CBHY70HF	50.3	33	601	48.5		
830	CBHY80HF	69	48	700	50		

CIRCULAR HYDRAULIC MANHOLE COVERS



Dimensions of frame	Shape		Reference	Mass (in kg)		Dimensions mm	
	Frame	Cover		Total	Cover	Clear opening	Frame depth
437	CBHY40SF	11.6	7.3	340	30		
537	CBHY50SF	20.9	12	407	48		
700	CBHY70SF	40	27.4	600	60		

PAVEMENT MANHOLE COVERS WITH SQUARE FRAME



Dimensions of frame	Shape		Reference	Mass (in kg)		Dimensions mm	
	Frame	Cover		Total	Cover	Clear opening	Frame depth
300	CBTB30RF	5.7	1.8	175	17		
400	CBTB40RF	10	3.8	250	18		
500	CBTB50CF	18.5	6.7	350	30		
600	CBTB60RF	25.5	9.5	425	30		
700	CBTB70RF	36.4	13.4	500	35		
800	CBTB80CF	54.5	26	610	35		

PAVEMENT MANHOLE COVERS WITH CIRCULAR FRAME



Dimensions of frame	Shape		Reference	Mass (in kg)		Dimensions mm	
	Frame	Cover		Total	Cover	Clear opening	Frame depth
800	CBTB80RF	38.5	26	610	35		

NB: references available in C250 class page 20, "PAYSAGE"

MEDIUM CLASS B125



Ductile iron
Polyethylene ring
EN 124



	Frame	Reference	Mass (in kg)		Dimensions mm	
			Total	Cover	Clear opening	Frame depth
	Square	CBTC60CFX24	57			

Based on the same design principle as the PAYSAGE, the MEDIUM manhole cover is the ideal solution for areas subjected to occasional, light traffic. Its polyethylene ring ensures stability and prevents rocking.

TEK



- Class B125
- Automatic locking by spring bar
- Hinged cover, opens to 115°
- Optional locking system
- Optional cover anti-theft spline
- EN124

Type	Type of frame	Reference	Mass (in kg)		Dimensions mm		
			Total	Cover	Frame overall	Clear opening	Frame depth
Ventilated	Round	CBTE60DU	46	26	785	600	100
Non-ventilated	Round	CBTE60EU	46	26	785	600	100

OPTEA

OPTEA Square single sealed access cover



- Class B125
- Anti odor function
- EN124

Type of frame	Reference	Mass (in kg)		Dimensions mm		
		Total	Cover	Frame overall	Clear opening	Frame depth
Square	CBOP30HK	5.9	3.7	300	235	25
Square	CBOP40HK	9.2	6.4	400	325	25
Square	CBOP50HK	15	11	500	400	30
Square	CBOP60HK	24	19.6	600	500	30

Technical characteristics of manhole covers

Strength class	Type of manhole cover	Pages	FRAME		COVER	STRENGTH		
			Shape	Dimensions mm	Clear opening mm	Type of traffic	strength margin	Strength factor
F 900	URBAMAX 900	9	Circular and square	850	600	INTENSE	○○○	++++
E 600	URBAMAX 600	9	Circular and square	850	600	INTENSE	○○○	++++
D 400	PAMREX "600"	11	Circular and square	850/840	610	HEAVY	○○○	++++
	PAMREX apparent frame	11	square	850	610	HEAVY	○○○	++++
	PAMREX "700"	12	Circular and square	900/950	700	HEAVY	○○○	++++
	PAMREX "800"	12	Circular and square	1000/1000	800	HEAVY	○○○	++++
	VIATOP NIVEAU	13	Circular	1135/1138	610	HEAVY	○○○	++++
	AMBER	13	Circular	785	600	HEAVY	○○	+++
	KORUM	15	Circular and square	841	606	HEAVY	○○	++++
	REXESS	16	Circular and square	900/785/850	600	NORMAL	○	+++
	G-TEX	18	Circular and square	850/850	600	LOW	○	++
	RC 40	18	Circular and square	850/815	600	LOW	○	++
	PAMTIGHT	14	Circular	850	600	NORMAL	○○	+++
	INTER-AX2	14	square	800x800	600x600	NORMAL	○	+++
C 250	PAYSAGE	20	Circular and square	850/850	600	-	○	+++
	PARXESS	20	square	450 to 730	300 to 600	-	○○○	++++
	MANHOLE COVERS FOR INSPECTION CHAMBERS	21	Circular and square	360/318	225/180	-	○	+++
B 125	AKSESS	22	square	310 to 820	220 to 700	-	○○○	++
	MEDIUM	25	Circular and square	850/815 x 815	600	-	○○○	++
	Various pavement covers	25				-		

STABILITY

Frame depth mm	Frame/cover seating	Depth of insertion mm	Stability factor
100	Elastomer ring	85	++++
100	Elastomer ring	85	++++
100	Elastomer ring	85	++++
160	Elastomer ring	85	++++
100	Elastomer ring	85	++++
125	Elastomer ring	76	++++
140/200	Elastomer ring	72	++++
104	Composite ring	Locked	+++
96	Composite ring	63	++++
100	Composite ring	Locked	+++
100	PE ring	Locked	++
75	PE ring	55	+
100	Elastomer and PE ring	Bolted	+++
100	Metal/metal	Fastened	+++
75	PE ring	Not applicable (EN 124)	+++
56	Non-rock system	Not applicable (EN 124)	++++
180/154	Metal/metal	Not applicable (EN 124)	+++
37 à 41	Non-rock system	Not applicable (EN 124)	++++
75	PE ring	Not applicable (EN 124)	+++

OPERATING-FACTORS

Special device	Operating factor
	++
	++
Ball-joint	++++
Ball-joint	++++
Ball-joint	++++
Double ball joint	+++
Ball-joint	++++
Spring bar	++++
Ball-joint	++++
Spring bar Hinge	+++
Spring bar	++
	++
	+
	++
	+++
	++++
For chambers ø 300 and 250	++++
Two opening modes	++++
	++

STRENGTH, STABILITY AND OPERATING FACTORS

=
Multiple-criteria comparison between products within the same class only (Class D 400, for example).

BREAKING STRENGTH MARGIN

=
Comparison between average breaking strength of the product and the EN 124 requirement.

○ = Average breaking strength up to 20% higher than EN 124 requirement.

○○ = Average breaking strength up to between 20% and 30% higher than EN 124 requirement.

○○○ = Average breaking strength more than 30% higher than EN 124 requirement.

NOTE

- Strength margins are specified with regard to the classes of utilization to which the respective products correspond.

- The field of application of products is limited to their utilization class by design.

How to install D 400 manhole covers

- Check the diameter of the manhole opening or groove that the frame is to be fitted on.
If necessary, insert a formwork around and/or inside the manhole on which the cover is to be fitted.
Make sure that the frame does not lay on the formwork when in its final position.



- Check the condition of the manhole opening or groove, removing any debris, loose particles or dirt (oil, grease, etc.). Remove any dust from the support.

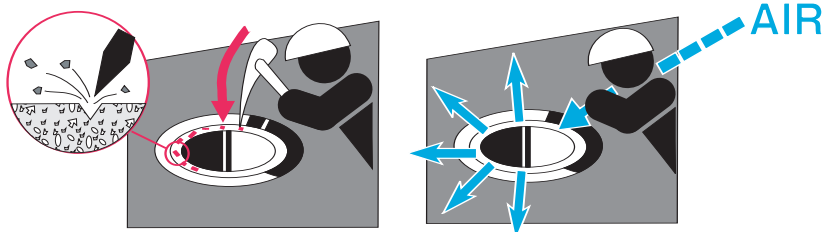

- Do not use any (metal or wooden...) brackets, or any threaded spindles when adjusting the height of the frame.

 The cover must only be in contact with the sealing product!

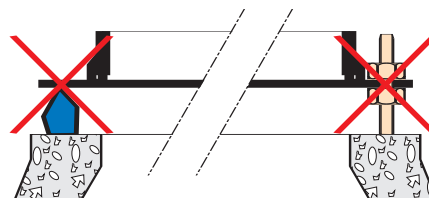

- Lay a coat of sealing product around the top of the manhole. The minimum recommended thickness for the coat under the frame, once installed and levelled, is:
 - 4 cm in the case of quick setting "micro-concrete" type sealing products,
 - 8 cm in the case of a 350 CPA concrete sealing.

It is essential to follow very carefully the instructions of the product used.

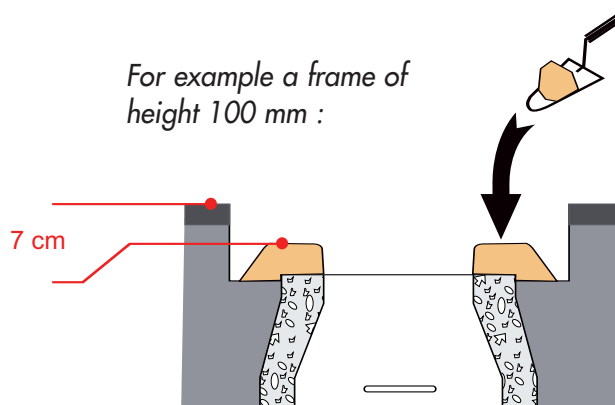

- Lay the frame directly on the sealing product.

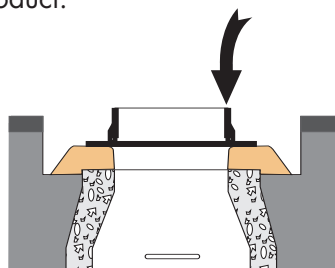

How to install D 400 manhole covers

- Adjust the frame to the same level as the wearing course. This adjustment should be carried out by exerting downward pressure on the frame to ensure that the sealing product spreads evenly under the surface. If the frame is situated below the surface level, then you must go back to point 4 (page 28) and repeat the operation.

With 350 CPA concrete

≥ 8 cm

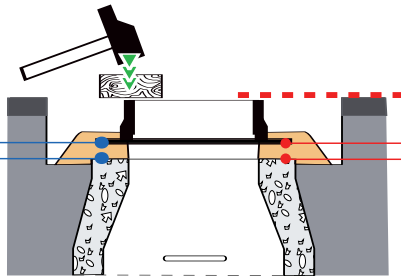

With quick-setting concrete

≥ 4 cm



- Check that the frame openings have been completely filled.

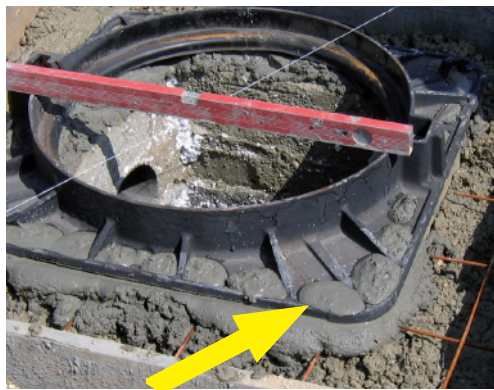

- Fill with sealing product. At this stage you may opt to vibrate the concrete using vibrating needles, providing that you ensure that this will not alter the level of the frame.

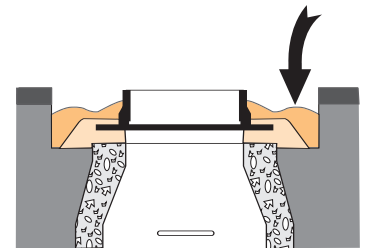

- Use a float or trowel to level off the product, leaving 3 to 5 cm for the later laying of the asphalt course.

30 / 50 mm

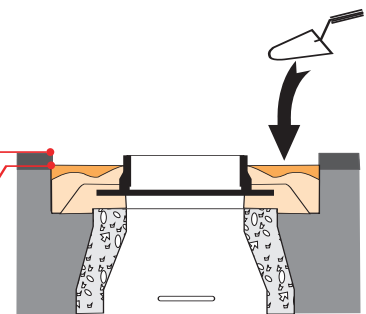

PLEASE NOTE

Following installation, it is essential to check that the sealing product is not touching the lower section of the ring and prior to use, clean the manhole cover and the surrounding area thoroughly. Particular care must be taken with the operating parts, namely the hinges, the elastomer ring or others, the bases, the spaces for the openings, etc. In the case of PAMREX covers, leave a clearance space under the hinge box.

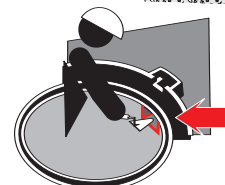
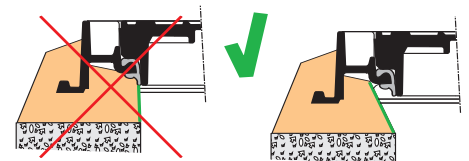

USEFUL TIP

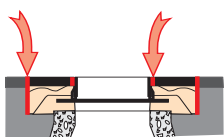

In order to ensure that the sealing will last, especially under conditions of frost and thawing, we advise eliminating the water inlets on the sealing/roadway and sealing/frame interfaces by using either a liquid emulsion or a flexible joint.

New Ranges Duct cover: T-MAX

DUCT COVERS T-MAX i D400

Hinge built into the basic version:

- Flat lifting by two operators
- Articulated : Opening by an operator
- Very simple 90° blocking (releasing)



All Iron frame:

- Ductile iron frame welded by robots
- Total height 120 mm

Safety or opening assistance kits:

- To be mounted on the site after installation of the duct cover
- The structure requires no preparation
- Installed with a limited number of tools : hammer, wrench 19 mm



Reference with telecom logo	Reference without logo	Chamber type	Nr of covers	C.O./mm	Weight/kg	Packing
-----------------------------	------------------------	--------------	--------------	---------	-----------	---------

D400 type K-Ductile iron frame and triangular with built-in hinge

DDK1ARTXTEL	DDK1ARTX	K1C	2	750 x 750	128.5	4
DDK2ARTXTEL	DDK2ARTX	K2C	4	1500 x 750	238.0	4
DDK3ARTXTEL	DDK3ARTX	K3C	6	2250 x 750	349.0	4

Kits: to be installed on site

Type	Description	Reference	Weight/kg
Opening assistance kit for 2 covers ⁽¹⁾	- 2 anti-ejection clips to be screwed on the frame - 2 oscillating fasteners to be installed under the cover - 2 gas springs with stainless steel quick couplings	D 28	2.8
Safety kit for K1C duct cover	- Lock with SCS head ⁽²⁾ - Safety clamp for master cover - 2 safety clamps for slave covers	D 25	2.2
Safety kit for K2C duct cover	- Lock with SCS head ⁽²⁾ - Safety clamp for master cover - 6 safety clamps for slave covers	D 26	4.0
Safety kit for K3C duct cover	- Lock with SCS head ⁽²⁾ - Safety clamp for master cover - 10 safety clamps for slave covers	D 27	5.8
SCS key for safety kit		C 18	0.4

(1) If assistance is required for all covers, order 2 kits for a K2C duct cover and 3 for a K3C duct cover

(2) Other locks are developed for special work sites or specific operators.

Plate hammer

Reference	Description
D10	FT homologated plate hammer
D11	Simplified plate hammer



Unit Installation manual included

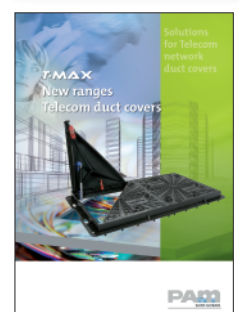

New Ranges Duct cover: T-MAX

DUCT COVERS T-MAX i C250

Standard component:

- Additional functions with kits to be installed on site
- Simple, reliable and patented technical solutions

2 covers C 250 with standard format*

- Covers interchangeable with old generation covers
- Optimized 900x633 mm: 61 kg instead of 80 kg
633x495 mm: 26 kg instead of 36 kg
- Equipped in factory of soundproofing pads

* Single covers also available in classes C 250 AND B 125



Angle bar frame 60x60x6 mm.
Identical to the current frame
but with 2 holes to fix the
ductile iron hinges.

Reference with telecom logo	Reference without logo	Chamber type	Nr of covers	C.O./mm	Weight/kg	Packing
-----------------------------	------------------------	--------------	--------------	---------	-----------	---------

C250 type L1T to L4T - Optimized steel angle bar frame and ductile iron covers

DCL1TMIXTEL	DCL1TMIX	L1T	1	527 x 389	38.3	5
DCL2TMIXTEL	DCL2TMIX	L2T	2	1161 x 389	71.7	5
DCL3TMIXTEL	DCL3TMIX	L3T	3	1381 x 527	101.3	5
DCL4TMIXTEL	DCL4TMIX	L4T	4	1876 x 527	132.6	5
DC1LTMIXTEL	DC1LTMIX	1/2L4T	2	884 x 527	69.9	5

C250 type P2T to M2T - Optimized steel angle bar frame and ductile iron covers

DCP2MIXTEL	DCP2TMIX	P2T	2	1161 x 884	146.7	5
DCL5MIXTEL	DCL5TMIX	L5T	3	1795 x 884	214.6	5
DCL6MIXTEL	DCL6TMIX	L5T	4	2429 x 884	282.7	5
DCM2MIXTEL	DCM2TMIX	M2T	5	3062 x 884	350.8	5

The kits quantity to be ordered depending on the type of chamber

Chamber type	Safety and Hinge	Chamber type	Safety and Assisted opening
L1T	1 kit D29 0	P2T	1 kit D31 1 kit D32
L2T & 1/2 L4T	1 kit D29 1 kit D30	L5T	2 kits D31 1 kit D32
L3T	1 kit D29 2 kits D30	L6T	2 kits D31 2 kits D32
L4T	2 kits D29 2 kits D30	M2T	3 kits D31 2 kits D32

Unit Installation manual included



DUCT COVERS T-MAX OPTIMISÉES C250 ou B125

Angle bar frame: galvanized steel 50x30x5 mm / C250 type LOT / C250 type L1T to L4T

Reference with telecom logo	Reference without logo	Chamber type	Nr of covers	Dimensions outside frame/mm	O.L./mm	Weight/kg	Packing
-----------------------------	------------------------	--------------	--------------	-----------------------------	---------	-----------	---------

C250 type LT- steel angle bar frame 50x30x5 mm and optimized frame 578x468 mm equipped of soundproofing pads

DCL1LIGXTEL	DCL1LIGX	L5T	1	641 x 481	581 x 421	28.0	10
DCL2LIGXTEL	DCL2LIGX	L2T	2	481 x 1221	1161 x 421	53.5	5
DCL3LIGXTEL	DCL3LIGX	L3T	3	591 x 1469	1409 x 531	77.7	5
DCL4LIGXTEL	DCL4LIGX	L4T	4	591 x 1938	1878 x 531	102.4	5
DC1LLIGXTEL	DC1LLIGX	1/4L4T	2	591 x 1000	940 x 531	58.8	5

Reference with telecom logo	Reference without logo	Chamber type	Nr of covers	Dimensions outside frame/mm	O.L./mm	Weight/kg	Packing
-----------------------------	------------------------	--------------	--------------	-----------------------------	---------	-----------	---------

B125 type LT- steel angle bar frame 50x30x5 mm and optimized frame 424x294 mm equipped of soundproofing pads

DBL0LIGXTEL	DBL0LIGX	LOT	1	308 x 488	428 x 248	13.4	10
-------------	----------	-----	---	-----------	-----------	------	----

DUCT COVERS PAMETIC2

Specific areas like: airports, bridges, industrial sites, laboratories, ... require a high level of sealing on duct covers for pit and specific chambers

3 main fields of application:

- Sealed duct covers with 1 to 3 covers on a row
- Sealed access covers for technical channels
- Sealed multispan duct covers

Performances :

- The bearing surface between frames and covers is completely machined : the precision of the components and the

absence of gap provide sealing, stability and complete silence

- Water and odours tight sealing assisted with special sealing grease
- Easy and safety opening with handling keys
- For multispan duct covers possibility of opening the selected cover

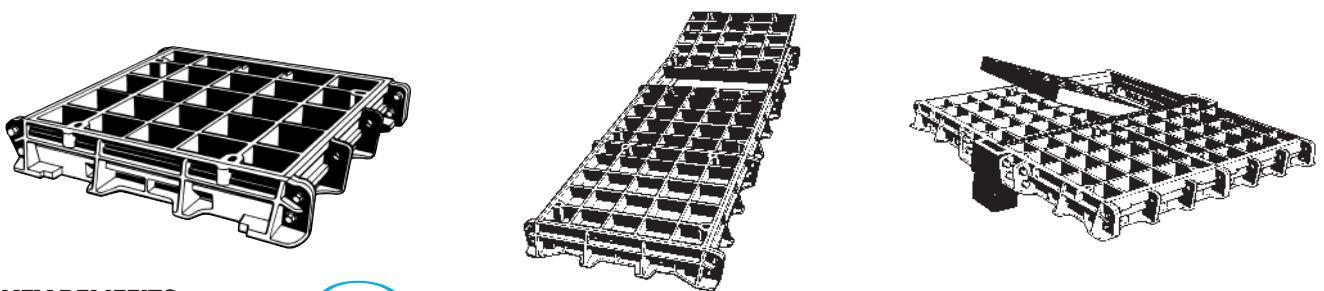

KEY BENEFITS

PAMETIC

by GATIC

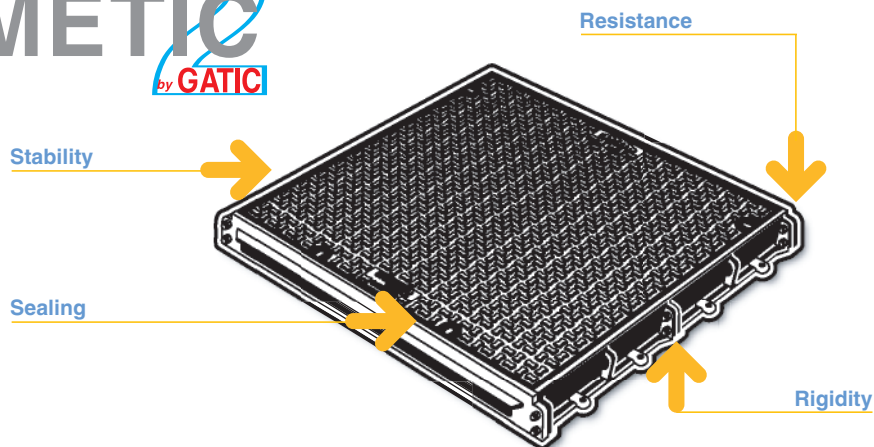

Easy installation •

Security •

Modular system •

Wherever **sealing, security and reliability** are required **PAMETIC** is the answer.
Ask for the specific catalogue

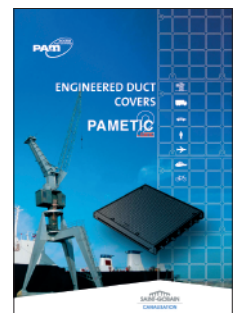

ACCESSORIES

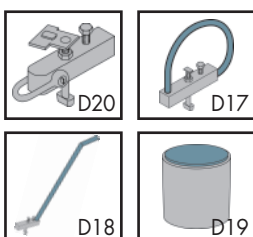

Reference	Designation	Detail
Accessories required for installation (Sold separately)		
D17	Standard keys	Set of 2 standard handling keys + a hexagonal key + a spanner
D18	Set of long handle keys	Set of 2 long handle manual lifting keys + a hexagonal key + a spanner
D19	Graphite grease	
Complementary accessories		
D20	Set of mechanical keys	4 keys per kit
D21	Plastic plugs	Sold per 100 pieces
Please contact us	Small clamps	Please consult us

Tree grates

“READY-ASSEMBLED” GRATES

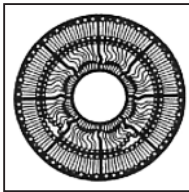

1 - DESLANDES
Grate

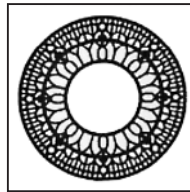

2 - MONET
Grate

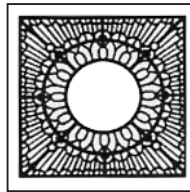

3 - FANTIN-LATOUR
Grate

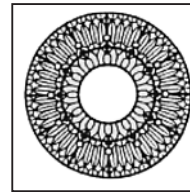

4 - DAUBIGNY
Grate

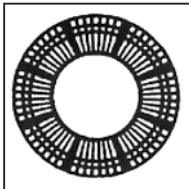

5 - SEURAT
Grate

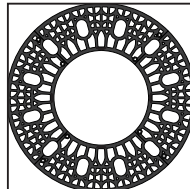

6 - Grate
CÉZANNE

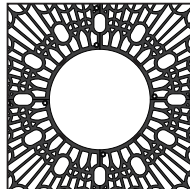

7 - Grate
GAUGUIN



Combining aesthetic appeal and strength, **PAM** tree grates protect trees from vandalism and damage by vehicles.

The various patterns are designed to fit in with all styles while providing a large enough area for the absorption of water and to allow trees to develop.

The grates can be fitted on a galvanized steel angle fitting/frame.

The opening of Monet, Fantin-Latour and Daubigny grates can be increased to 975 mm by cutting the central ring in order to promote tree growth.

HIGH PROTECTION GRATES

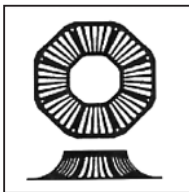

8 - ETNA
Grate

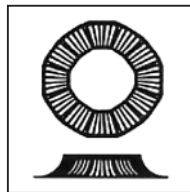

9 - SANTORIN
Grate

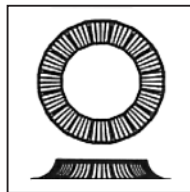

10 - KILIMANDJARO
Grate

Ductile iron 

Nota : References comprises all necessary elements for grate or frame assembly

Nota 2 : For spare elements ordering, please contact

Type	Reference	Unit mass kg	Nbr parts For information	Dimensions			Ventilated area %	
				External mm	Internal mm	Thickness mm		
1 - DESLANDES	Grate	EADE20	152	4	2000	600	27	45
	Frame	EODE20C	6.4	4				
2 - MONET*	Grate	EAM014	60	4	1414	600	17	45
	Frame	EOM014C	5.4	2				
3 - FANTIN-LATOUR*	Grate	EAFL14	92	4	1414	600	17	48
	Frame	E0FL14C	8	4				
4 - DAUBIGNY	Grate	EADA18	102	4	1800	600	17	52
	Frame	EODA18C	6.8	4				
5 - SEURAT	Grate	EASE10	52	2	1000	500	20	32
	Frame	E0SE10C	4	2				
6 - CÉZANNE	Grate	EACE10	30	4	1000	500	17	47
	Frame	E0SE10C	4	2				
7 - GAUGUIN	Grate	EAGA10	34	4	1000	500	17	54
	Frame	E0GA10C	5.6	4				
8 - ETNA	Grate	EAET12	48	4	1200	460	20	-
	Frame	E0ET12C	4.4	4				
9 - SANTORIN	Grate	EASA14	60	4	1450	740	20	-
	Frame	E0SA14C	5.6	4				
10 - KILIMANDJARO	Grate	EAKI17	72	4	1720	1000	20	-
	Frame	E0KI17C	6.4	4				

(*) Grates can be combined together.

T

he collection of run-off water has become a major concern :

- ▲ the development of impermeable surfaces considerably increases the volumes to be drained,
- ▲ while, at the same time, sewer system operating constraints are changing user needs, especially with regard to the filtering of debris and access for maintenance operations.

On the strength of its recognized experience in sewerage and its know-how as the leading European manufacturer of municipal castings, **PAM** offers a range of drain gratings that provide users with efficient, reliable and durable solutions. Always attentive to customer needs, **PAM** is constantly seeking to improve its product ranges to satisfy future requirements.

	Pages
PAMREX gratings	37
REXEL, PAYSAGE gratings	38
DEDRA	39
SQUADRA gratings	40/41
Square frame gratings	42/43
Kerbside gratings	44
SELECTA gully units	45/47
Gully units, Communal Grating	48/49
AUTOLINEA channel gratings	50/51
Channel gratings	52/53

TYPE OF COLLECTION

Run-off water can be collected either :

- by gully grates in a road carriageway or in a parking area, or by kerbside gully units.
- Linear collection, by channel gratings.

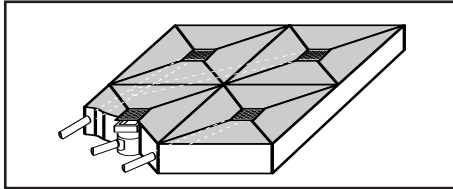

Multi-directional collection

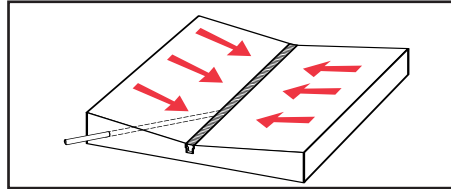

Channelled drainage

LOCATION OF GULLY POT

The type of grating to be used is generally determined by the location of gully pots and the design of the drainage network.

- When the gully pot is situated directly under the carriageway, a square flat grating is used.
- When the gully pot is positioned to provide kerb and carriageway drainage, either a gully grate or a SELECTA inlet should be used.
- When gully pots are sited under the foot-path, units which incorporate a cover plate and grate are used.

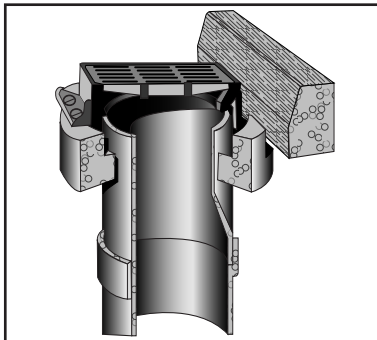

Gully pot positioned under carriageway

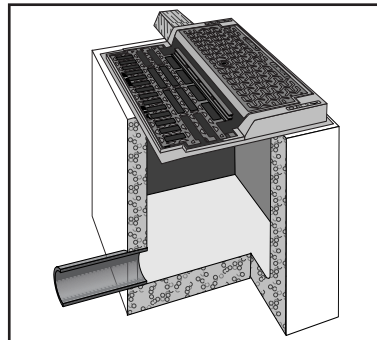

Kerb or carriageway combination

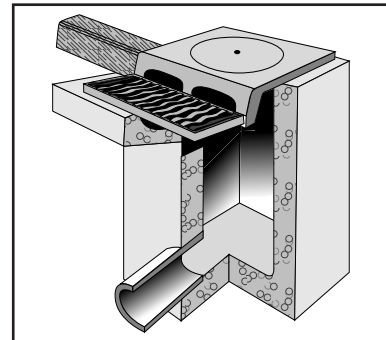

Gully pot positioned under pavement

TRAFFIC RESISTANCE

Like manhole covers, gully grates must be selected according to their place of installation as this determines their strength class in accordance with the definition in EN 124 (see page 6).

DECISION-MAKING AID

In order to help customers make their choice among the various gully units, frame gratings and channel gratings in the gully grates range, **PAM** has prepared a dimensioning and decision-making aid software package.

It can be used to determine the following points on the basis of the characteristics of the site studied :

- the type of grates,
- the number of grates to be used,
- the spacing between two successive castings,
- the quantity of rainwater drained by the sewer system.



Please consult our sales engineering teams.

Selection criteria for gully grates

RANGE

Confronted to the wide diversity of situations encountered, users are increasingly choosing specific drain inlet devices in order to optimize the collection of rainwater and run-off water.

In response to this demand, **PAM** provides a wide range of products constituting suitable technical solutions for each specific configuration.

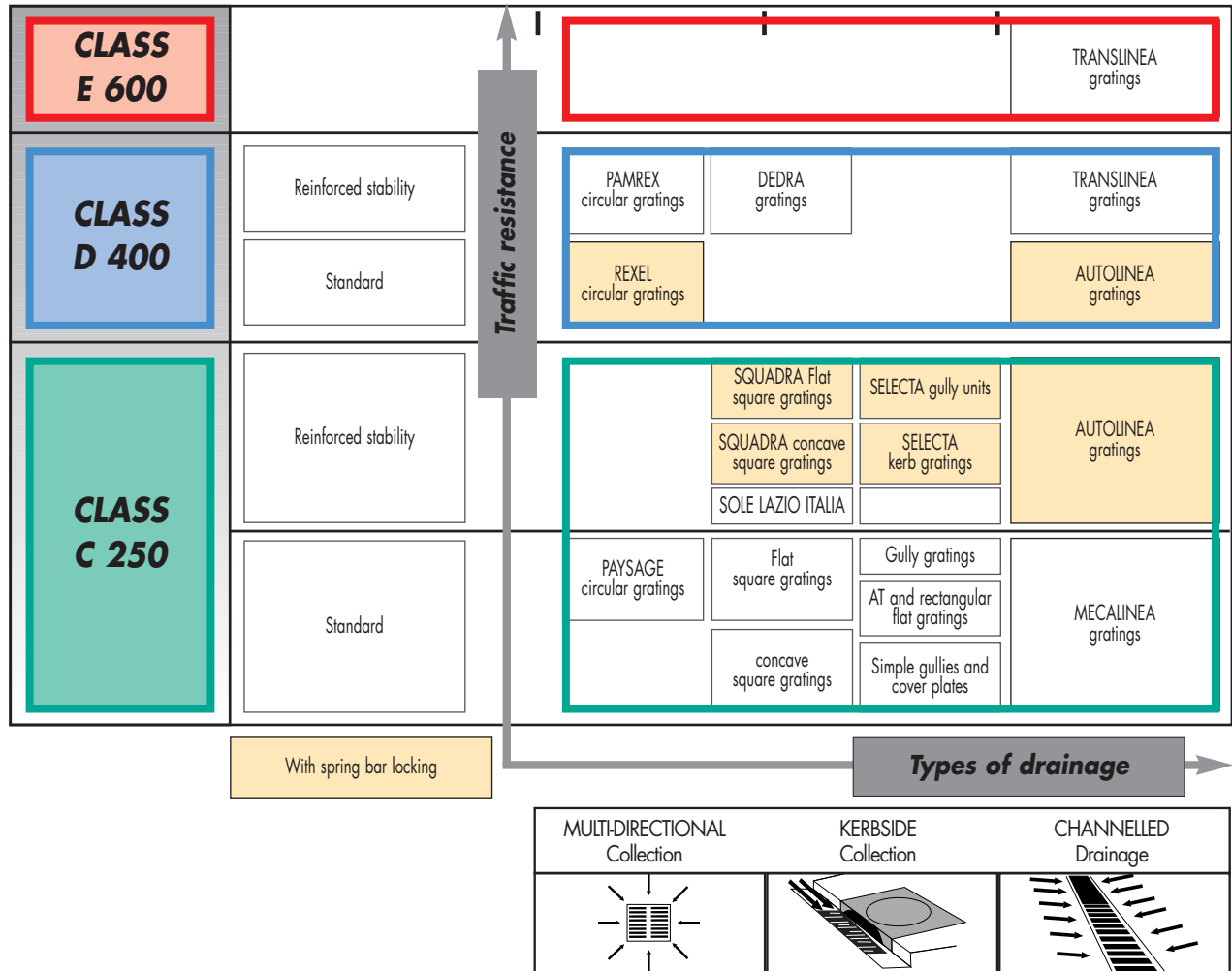

GRATING GATIC FOR AIRPORTS F900

- Ductile Iron
- Machined and greased seating faces
- 2 levelling bolts on each side bar (level setting)





Reference	Clear opening	Outside frame dimension mm		Mass kg
EFGR83ZX	850 x 300	900 x 570 x 140	Grate with frame	96
EFCL30JX		850 x 570 x 140	Grate on 2 side bars	85
E14			End plate*	5.5
EFGR84ZX	850 x 450	900 x 720 x 140	Grate with frame	122
EFCL45JX		850 x 720 x 140	Grate on 2 side bars	108
E15			End plate*	7
EFGR86ZX	850 x 600	900 x 870 x 140	Grate with frame	227
EFCL60JX		850 x 870 x 140	Grate on 2 side bars	210
E16			End plate*	8.5
EFGR77ZX	700 x 750	750 x 1020 x 140	Grate with frame	248
EFCL75JX		700 x 1020 x 140	Grate on 2 side bars	228
E17			End plate*	10

* for channel application: use gratings with side bars and 2 end plates



PAMREX GRATING

- Ductile iron
 - Class D 400
 - hinged
 - Elastomer ring
 - 1 handling box
 - Lifting rings integral with the frame
 - Optional anti-theft grate locking
 - Interchangeable with PAMREX cover
- EN 124  

Completely interchangeable with PAMREX covers, the grating withstands the most intense traffic. Silent thanks to its elastomer ring, the PAMREX grating is innovative owing to its hinge mechanism which facilitates opening and allows locking safety. It can be used on an ad hoc basis during sewer inspections or on a permanent basis to ventilate systems and reduce the risks of hydrogen sulphide formation.



PAMREX safety : cover opening to 130°, 90° locking on closing.

Type	Frame	Reference	Mass kg		Dimensions mm		Waterway area dm ²
			Total	Grating	Clear opening	Frame depth	
Safety	Round	EDPA60AF	91	58	610	100	10.75
	Square	EDPA60	100				
Operation	Round	EDPA60BF	91				
	Square	EDPA60DF	100				

• PAMREX accessories, see page 19

Circular gratings

REXEL GRATING

- Ductile iron
- Class D 400
- Automatic locking by ductile iron spring bar (patented system)
- Hinge
- Unlocking box
- Optional anti-theft grate locking
- Rexel grate is interchangeable with cover
- EN 124  

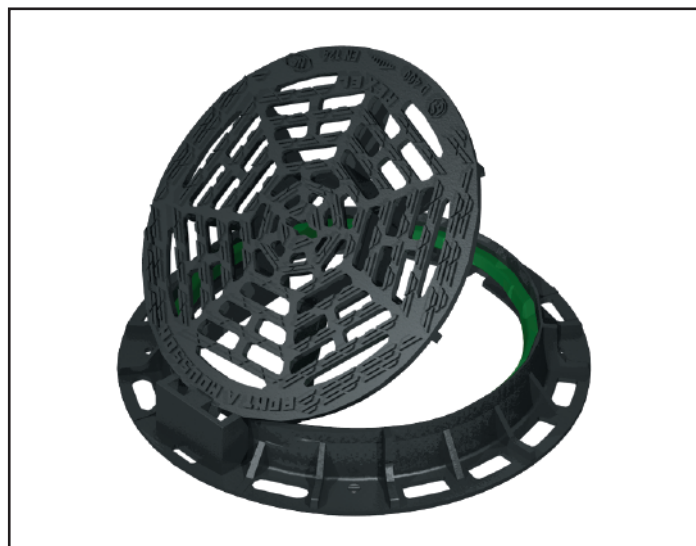

The REXEL grating is specially designed to withstand medium-density traffic. Its design ensures performance, long-life and stability.



Frame	Reference	Mass kg		Dimensions mm		Waterway area dm ²
		Total	Grating	Clear opening	Frame depth	
Circular	EDRX60BF	57	32	600	100	11.9
Square	EDRX60DF	65	32	600	100	11.9



LOCKING KITS

See page 17

PAYSAGE GRATING

- Ductile iron
- Class C 250
- Polyethylene ring
- Interchangeable with PAYSAGE cover
- EN 124  

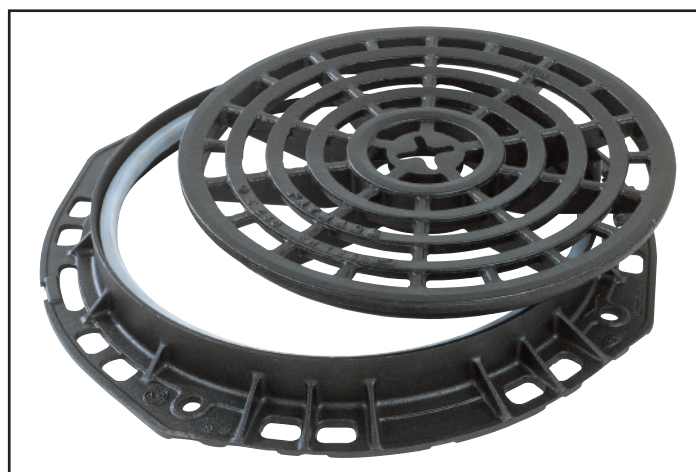

The PAYSAGE grating is installed on shafts sited in traffic-free locations. The concave shape of the concentric bars optimizes multi-directional collection.

Frame	Reference	Mass kg		Dimensions mm		Waterway area dm ²
		Total	Grating	Clear opening	Frame depth	
Circular	ECPY60BF	55	36	600	75	13.5
Square	ECPY60DF	62				

DEDRA GRATINGS D400



■ A new range of gratings designed for all types of traffic stresses, carriageways, parking, kerbside..., thanks to its high performances stability features.

Details of the DEDRA product:

- Flat square gratings with 4 side-flange frames (street setting) and 3 side-flange frames (kerb setting)
- Concave gratings with 4 side-flange frames

Two types of frames available:

- With standard opening
- With round opening
 - forming a mud-pan (ref: E4 not supplied) bearing plate and centring studs for pipes and 400 ND plastic extensions

FLAT AND CONCAVE* HINGED GRATINGS DEDRA 400

Type of frame		Grating shape	Mass kg		Dimensions mm			Waterway area dm ²	Reference
Sides	Suitable for Mudpan		Total	Grating	Frame	Clear opening	Height		
3 Sides	no	flat	51.1	28.7	600 x 550	400	102	11.3	EDDE40RFX14
	yes		56.8	28.7		350	102		EDDE35RFX14
4 Sides	no		52.4	28.7	600 x 600	400	102		EDDE40DFX14
	yes		58.1	28.7		350	102		EDDE35DFX14
	no		52.3	28		400	127		EDDE40DFX15
	yes		60	28		350	127		EDDE35DFX15

*restriction of use according to EN 124 standard



DEDRA 400 flat 4 side-flange frame



DEDRA 400 concave 4 side-flange frame



DEDRA 400 concave 4 side-flange opened

FLAT HINGED GRATINGS DEDRA 600

Type of frame		Grating shape	Mass kg		Dimensions mm			Waterway area dm ²	Reference
Sides	Suitable for Mudpan		Total	Grating	Frame	Clear opening	Height		
4 Sides	no	flat	88.2	50.6	800 x 800	600	100	18.7	EDDE60DFX14
3 Sides			85	50.6	800 x 714				EDDE60RFX14

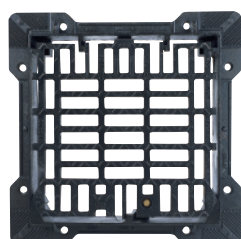

Frame 4 side-flange

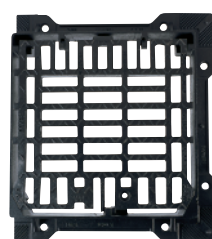



Frame 3 side-flange



DEDRA 600 4 side-flange frame

Square gratings with frames and automatic locking

SQUADRA FLAT AND CONCAVE C250

- Ductile iron
Class C 250
Secured by patented ductile iron
spring-lock mechanism
EN 124  

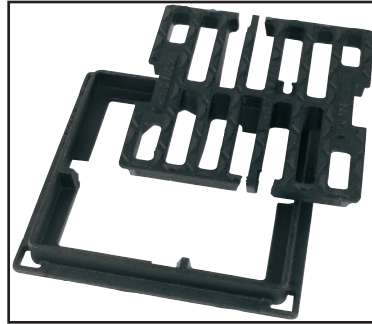

Flat SQUADRA



Concave SQUADRA

Successfully developed with AUTOLINEA gratings and the REXEL manhole cover, the ductile iron spring locking mechanism equips SQUADRA gratings. Locking of the gratings and a newly designed frame provide maximum stability and more precise installation on the gully pot.

STABILITY ++++

SQUADRA gratings incorporate a feature considered by users to be increasingly important: **stability**.

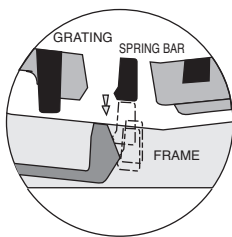

The "T"-frame ensures optimum seating of the grating, and better assembly fit on the concrete gully pot.

INSTALLATION AND OPERATION ++++

- flat soled frame for practical and effective embedment
- compatible with prefabricated concrete manholes
- easy to open by system service teams using a crowbar or pickaxe as lever
- easy to close automatically : place the grating into its frame, exert pressure on the grating with foot or tool to lock it safely»

SAFETY ++++

- Flat SQUADRA gratings can be rotated 90°: the click-in system operates whatever the position of the grating in its frame. This feature means the bars can be placed perpendicular to the flow of traffic, irrespective of the way in which the frame has been sealed into place.
- Concave SQUADRA gratings also provide maximum safety with bi-directional bars ensuring safety for cyclists and pedestrians.

ABSORPTION ++++

- The bars have been specially developed to optimize absorption. In particular, the presence of a range of directional facets facilitates the washing away of leaves, and also breaks up the water sheet.
- Flat SQUADRA: rotate the grating in the frame to optimize absorption.
- Concave SQUADRA: dual bar orientation for maximum performance.



SQUADRA gratings with frame and automatic locking

SQUADRA FLAT GRATING

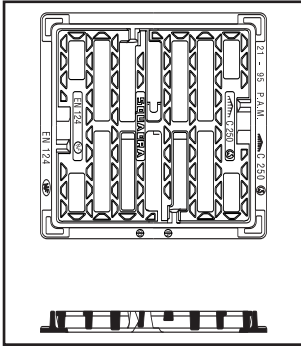

Reference	Mass kg		Dimensions mm			Waterway area dm ²
	Total	Grating	Frame	Clear opening	Depth	
ECSQ35PF	15.3	10	350	250	39	2.7
ECSQ40PF	20.1	13.6	410	300	39	5.2
ECSQ50PF	26.5	19	510	400	39	9.8
ECSQ60PF	42	25.7	620	500	39	15.1
ECSQ70PF	60	47	720	600	39	20.6
ECSQ80PF	77	63	820	700	39	28.5

SQUADRA 500 FLAT GRATING WITH HIGH FRAME



for paved areas and pavements, can be fitted with mudpan

Reference	Mass kg		Dimensions mm			Waterway area dm ²
	Total	Grating	Frame	Clear opening	Depth	
ECSQ50LF	35.5	19	510	350	100	9.8

MUDPAN FOR SQUADRA 500 FLAT GRATING WITH HIGH FRAME

E4	7.0	-	385	325	600	-
----	-----	---	-----	-----	-----	---

SQUADRA 500 FLAT GRATING ACCESS FOR DISABLED PEOPLE



- French decree N° 2006-1658 relating to the technical dispositions for accessibility of municipal castings and public areas.
- french order of january 15th, 2007 relating to the application of the decree above.

ECSQ35PFX11	14.9	9.6	350	250	39	3.0
ECSQ40PFX11	12.2	12.25	410	300	39	3.9
ECSQ50LFX11	37.5	21	510	400	100	7.8
ECSQ50PFX11	28.5	21	510	400	39	7.8
ECSQ60PFX11	29	29	620	500	39	12.8
ECSQ70PFX11	61.5	48.5	720	600	39	17.6
ECSQ80PFX11	78.2	64.2	820	700	39	24.7

SQUADRA CONCAVE WITH FLAT FRAME

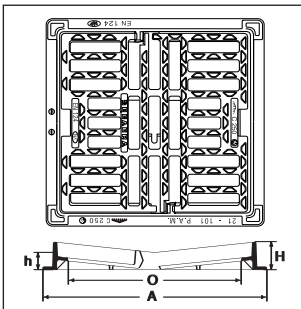

Reference	Mass kg		Dimensions mm			Waterway area dm ²
	Total	Grating	Frame	Clear opening	Depth	
ECSQ40CF	22.7	14.5	410	300	58/40	5
ECSQ50CF	30.4	19.5	510	400	63/40	9.8
ECSQ60CF	44.8	31.5	620	500	68/40	14.8
ECSQ70CF	63.7	48	720	600	73/40	20.7
ECSQ80CF	86.6	65.5	820	700	78/40	27.4

SQUADRA CONCAVE WITH FLAT FRAME FOR DISABLED PEOPLE



ECSQ40CFX11	20	11.8	410	300	58/40	4.8
ECSQ50CFX11	31.8	20.9	510	400	63/40	7.0
ECSQ60CFX11	44.1	30.8	620	500	68/40	12.8
ECSQ70CFX11	63.7	48	720	600	73/40	18.4
ECSQ80CFX11	81.3	60.2	820	700	78/40	26.4

Square gratings for kerbsides and car parks

GRATINGS WITH HIGH FRAME - C 250

- Ductile iron
- Class C 250
- Surrounding bedding flange
- EN 124  

The ITALIA, LAZIO and MILANO gratings have a raised frame and a surrounding flange which reinforce the strength of their bedding and provide greater safety under traffic load. The absence of ribs on the outer face of the frame facilitates the installation of the gratings on paved roads or areas.



Italia grating

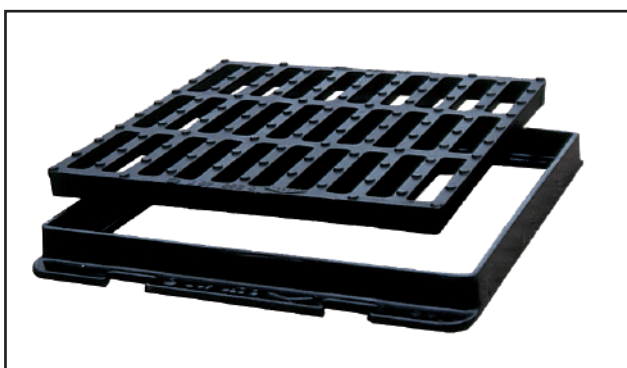

Milano grating



Lazio grating

■ FLAT GRATING : ITALIA

Base size mm	Reference	Mass kg		Dimensions mm			Waterway area dm ²
		Total	Grating	Frame	Clear opening	Depth	
400 x 400	ECIT36PF	27.3	13.7	500	360	80	7.7

■ CONCAVE GRATING : LAZIO

Base size mm	Reference	Mass kg		Dimensions mm			Waterway area dm ²
		Total	Grating	Frame	Clear opening	Depth	
500 x 500	ECLZ57CF	38.5	23.5	570	450	70	11.8

■ FLAT GRATING : MILANO

Base size mm	Reference	Mass kg		Dimensions mm			Waterway area dm ²
		Total	Grating	Frame	Clear opening	Depth	
500 x 500	ECGP50PF	31.8	22	560 x 500	440	45	11.8

Square gratings for kerbsides and car parks

SQUARE GRATING WITH FRAME - C 250

- Ductile iron
- Class C 250
- Bedding lugs
- EN 124  

Flat and concave square gratings provide a simple solution for the top of gully pots located in traffic-free areas.

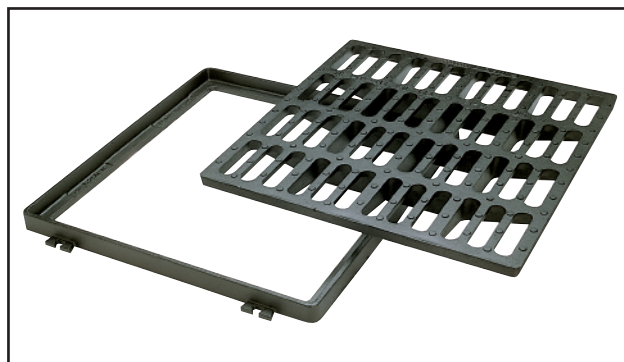

Flat square grating

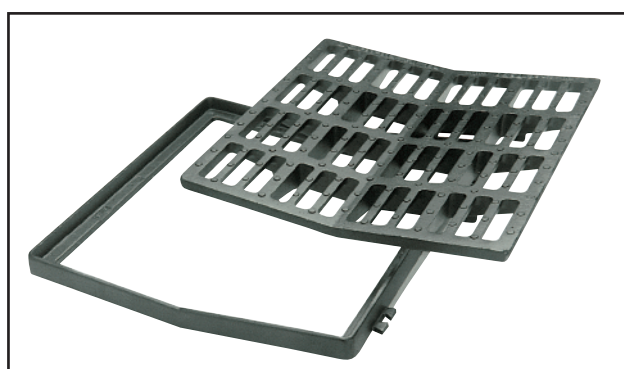

Square concave grating

FLAT GRATINGS

Base size mm	Reference	Mass kg		Dimensions mm			Waterway area dm ²
		Total	Grating	Frame	Clear opening	Depth	
200 x 200	ECGP20PF	6.8	3.8	218	165	27	1.7
250 x 250	ECGP25PF	9.6	5.8	269	215	27	2.4
300 x 300	ECGP30PF	13.0	8.0	319	255	27	4.2
400 x 400	ECGP40PF	21.3	17.7	462 x 422	351	27	7.7
500 x 500	ECGP56PF	32.7	20.8	563 x 523	450	27	11.8
600 x 600	ECGP60PF	48	36	664 x 624	549	27	16.8
700 x 700	ECGP70PF	77	61	765 x 725	647	27	20.2
800 x 800	ECGP80PF	94.5	74	867 x 827	744	29	27.6

CONCAVE GRATINGS WITH CONCAVE FRAMES

Base size mm	Reference	Mass kg		Dimensions mm			Waterway area dm ²
		Total	Grating	Frame	Clear opening	Depth	
400 x 400	ECGC40CF	21.8	14	462 x 422	351	40	7.7
500 x 500	ECGC50CF	31.1	21	563 x 523	450	40	11.8
600 x 600	ECGP60CF	49.4	37	664 x 624	549	40	16.8
700 x 700	ECGP70CF	75.5	59	765 x 725	647	42.5	20.2
800 x 800	ECGP80CF	96.5	75	867 x 827	744	42.5	27.6

Rectangular gratings for kerbsides

GRATING AT - FLAT GRATING WITH FRAME- C 250

- Ductile iron
Class C 250
EN 124  

Flat rectangular gratings with frames are usually installed at the kerbside, alone or in addition to a cover plate or a gully.



Grating AT

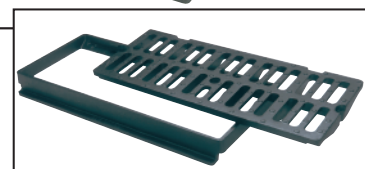



Flat grating

Type	Reference	Base size mm	Mass kg		Dimensions mm			Waterway area dm ²
			Grating	Total	Frame	Clear opening	Depth	
AT	ECCL30DF	750 x 300	25	40	776 x 345	746 x 241	41	8.7
Plate	ECML30ZF	750 x 300	20	41	776 x 345	746 x 241	41	7.5

SOLE GRATING





Ductile iron
Class C 250, 400 kN test load
Hinging on lengthwise
Handling box
Anti-theft grating
Reinforced frame
EN 124  

Easy to open, the SOLE grating is designed to allow quick access to sewer systems. Its raised frame is fitted with a three sides bedding flange, allowing solid and durable bedding at the kerbside, opposite a gully for example. The grating is anti-theft once it has been bedded.

Base size mm	Reference	Mass kg		Dimensions mm			Waterway area dm ²
		Total	Grating	Frame	Clear opening	Depth	
600 x 350	EC63EF	37.5	22	725 x 420	600 x 350	77	9

SELECTA KERB GRATINGS

- Ductile iron
Class C 250
Articulated grating
Locking feature due to spring-lock device
EN 124  

SELECTA kerb gratings are fully compatible with standard kerb dimensions as defined in French standard NF P 98-302. They are easy to install and are impeccably finished.

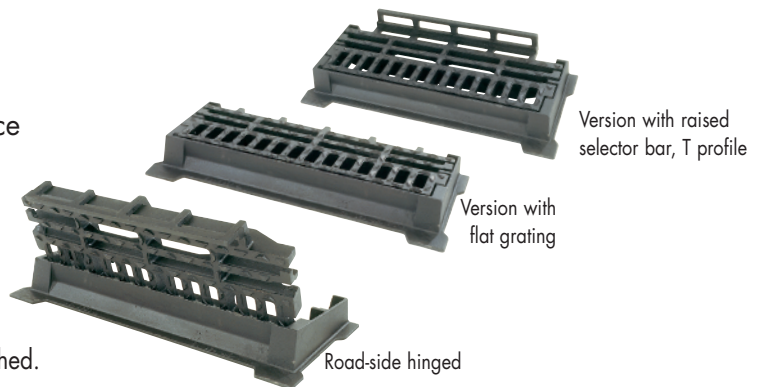

- Reinforced frame for complete stability and effective seating on concrete structures.

The SELECTA grating with T-profile raised selector bars is compatible with:

- T-profile cover plate, ref.: ECRV80TF,
- T-profile gully, ref.: ECAV80TF

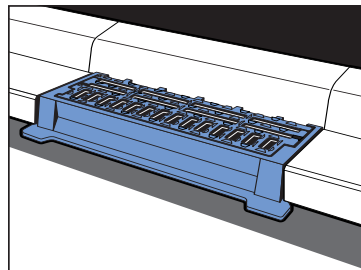
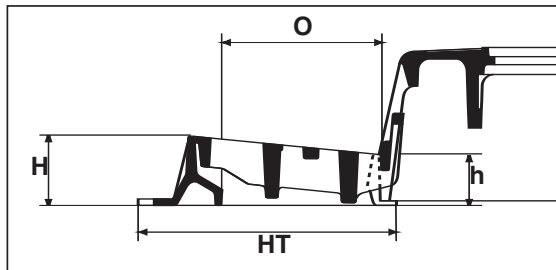
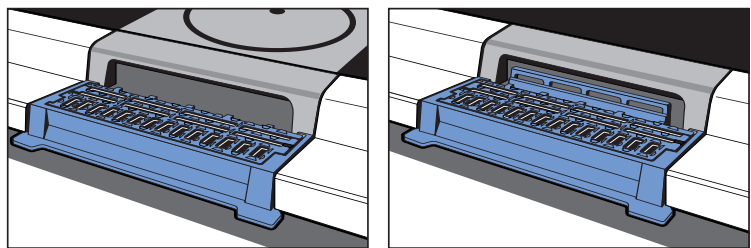

SELECTA grating installed alone.

Overall dimensions mm	References	Mass kg	Dimensions mm			Waterway area dm ²
			Overall HT	Opening O	Depth H/h	
Flat grating version						
800 x 340	ECSE80PF	33.8	800 x 340	660 x 205	90/68	9
With selector bar						
800 x 340	ECSE80UF	40	800 x 340	660 x 205	90/68	7

SELECTA KERB GRATING, ACCESS FOR DISABLED PEOPLE





- French decree N° 2006-1658 relating to the technical dispositions for accessibility of municipal castings and public areas.
- french order of january 15th, 2007 relating to the application of the decree above.

Overall dimensions mm	References	Mass kg	Dimensions mm			Waterway area dm ²
			Overall HT	Opening O	Depth H/h	
Flat grating version						
800 x 340	ECSE80PFX11	35	800 x 340	660 x 205	90/68	6.1

SELECTA gully units

SELECTA - C 250

- Ductile iron
- Class C 250
- Locking of the flaps by the elasticity of ductile iron (patented system)
- Adjustable to pavement level
- EN 124  

The result of intense cooperation between **PAM** and sewer system managers, the **SELECTA** gully unit is the professionals' solution to the problem of draining rainwater.



Selecta is available in two versions:

- (a) SELECTA MAXI height adjustable
- (b) SELECTA 500

- A or T-profile
- with raised selector bar grating
- with flat grating

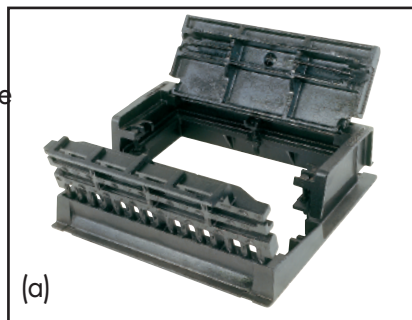

(a) *SELECTA Maxi, A-profile with raised selector bar grating.*



(b) *SELECTA 500, T-profile with flat grating*

■ SCREENING OF DEBRIS ++++

The presence of a raised bar prevents access into the gully for debris of too large a size and keeps certain solid objects carried by run-off water out of the sewer system.

■ SAFETY FOR PEDESTRIANS ++++

On the pavement side, the elimination of clearance on the hinge system and of any roughness on the surface of the cover ensure safety for pedestrians (high heels, walking sticks, crutches, etc.).

■ AUTOMATIC LOCKING ++++

ductile iron spring bar integral with grate and cover.

■ SAFETY FOR CYCLISTS ++++

On the carriageway, the bars are perpendicular to the direction of the traffic in order to ensure safety for cyclists.

■ DRAINAGE ++++

In the lower section of the gutter, the bars are arranged longitudinally in order to maximize water drainage. Simulations carried out on a test bench show increases of between 10 % and 15 % in absorption, in certain circumstances, compared with a traditional design consisting of a rectangular grating and a gully.

■ ADJUSTABILITY ++++

Three bolts allow the height adjustment (up to 50 mm) of the cover frame with respect to the kerb.

■ ANTI-OBSTRUCTION ++++

The surfaces of the bars are equipped with facets that are oriented in such a way as to prevent leaves or litter from blocking the drain.

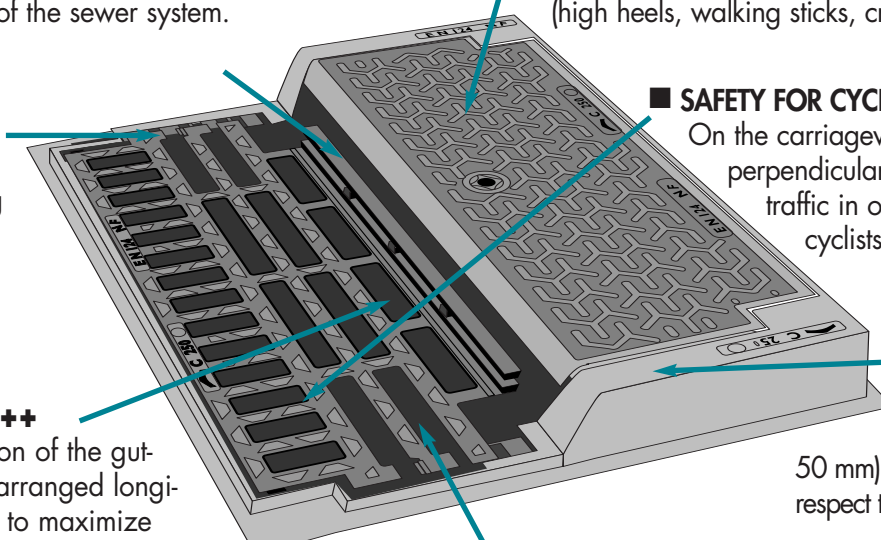

SELECTA MAXI level adjustment and maximum capacity

- SELECTA Maxi gullies are designed for mixed roadway/pavement installation.
- Cover and kerb leveled using 3 adjustment bolts integrated into the frame.
- Raised selector grating or flat grating.



SELECTA Maxi, A-profile with raised selector bar grating.



SELECTA Maxi, T-profile with raised selector grating



SELECTA Maxi, T-profile with flat grating

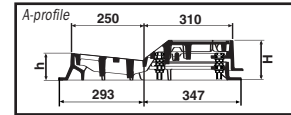
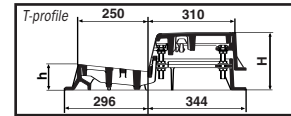

Kerb profile	References	Mass kg				Dimensions mm				Waterway area dm ² according to height adjustment
		Total	Grating	Cover	Raised section and frame	Overall	Depth H/h	Effective opening	Depth adjustment mm	
with raised selector bar grating										
Tprofile	ECSE75UFX11	94	26	24	44	750 x 640	225/90	540 x 450	50	10.1 à 13
Aprofile	ECSE75SFX11	86	25	22	39	750 x 640	155/90	540 x 450	20	9.4 à 10.7
with flat grating										
Tprofile	ECSE75UFX16	90	21.3	24	44	750 x 640	225/90	540 x 450	50	11.6 à 14.5

SELECTA 500 compact and high-capacity

- SELECTA 500 drain gullies are fitted on standardized gully pots (500 mm), and are designed for mixed roadway/pavement installation.
- Broad soled frame for effective seating on concrete structures. Dimensions compatible with gratings, gullies, bases, and concrete kerbing.
- Raised selector bar grating or flat grating



SELECTA 500, T-profile with raised selector bar grating



SELECTA 500, A-profile with raised selector bar grating



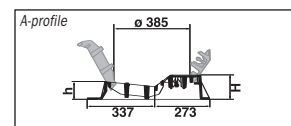
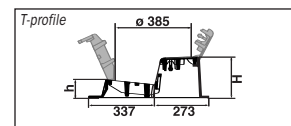

SELECTA 500 with T-profile flat grating



Kerb profile	References	Mass kg				Dimensions mm			Waterway area dm ²
		Total	Grating	Cover	Frame	Overall	Depth H/h	Effective opening	
with raised selector bar grating									
Tprofile	ECSE61TF	54.5	16.5	14	24	610 x 570	205/90	385	8.5
Aprofile	ECSE61SF	51	16.5	13	21	610 x 570	125/90	385	7.6
with flat grating									
Tprofile	ECSE61UF	53	15	14	24	610 x 570	205/90	385	9.8

Gully units

GULLY COVER PLATES AND INLETS - C 250

- Ductile iron
Classe C 250 (frame)
B 125 (cover)
EN 124  

The cover plates are designed to be fitted on large-sized gully pots under pavements (kerb or carriageway combination).

Inlets are simple versions of cover plates without cover.

COVER PLATES





Kerb profile	Reference	Mass kg		Dimensions mm			Waterway area dm ²
		Total	Cover	Overall	Clear opening	Depth	
Profile A	ECRV80AF	72	24	800 x 830	610	120	4.3
Profile T	ECRV80TF	75.6	24	800 x 830	610	200	6

INLETS



Kerb profile	Reference	Mass kg	Dimensions mm		Waterway area dm ²
			Overall	Depth	
Profile A	ECAV80AF	21	800 x 225	120	4.2
Profile T	ECAV80TF	28	800 x 225	200	6

GULLY GRATING - C 250

- Ductile iron
Class C 250
EN 124  

These inlet gratings are fitted on small-gully pots (500 mm) of a mixed road/pavement type installation. The grating's profile is specially designed to prevent obstruction by leaves or other debris whilst allowing the maximum drainage.





INLETS GRATING

Kerb profile	Reference	Mass kg		Dimensions mm			Waterway area dm ²
		Total	Cover	Overall	Clear opening	Depth	
Profile A	ECCA60AF	56	31	605 x 502	405	176	8
Profile T	ECCA60TF	62	32	605 x 502	405	233	9.15

COMMUNAL GRATING C 250



- Ductile iron
Class C 250
Sloped reinforced frame
Available with or without centring lug
Seating flange on 3 sides
EN 124  

The COMMUNAL grating is equipped with a sloped frame which automatically ensures a crossways slope. The bedding flange on three sides facilitates fitting along the kerb and ensures optimum stability.

NB : In case of intense traffic, we recommend the installation of the range DEDRA 400. See page 39.

Type	Base size mm	Reference	Mass kg		Dimensions mm			Waterway area dm ²
			Total	Grating	Frame	Clear opening	Depth	
With lugs	500 x 500	ECCP67PFX20	53	23.5	670 x 600	405	119	11.8
Without lugs	500 x 500	ECCP67PFX19	51.5	23.5				

OPTEA Flat Square grating C250



■ Ductile iron
Class C 250
EN 124 

Reference	Mass (in kg)		Dimensions mm			
	Total	Grating	Frame	Clear opening	Depth	Waterway area dm ²
ECOP30PK	8.1	4.8	300	200	36	2.3
ECOP40PK	13.8	9.7	400	303	36	5.2
ECOP50PK	19.2	14.0	500	400	36	9.5
ECOP60PK	29,2	22.7	600	500	36	15.3

OTHER CHANNEL GRATINGS

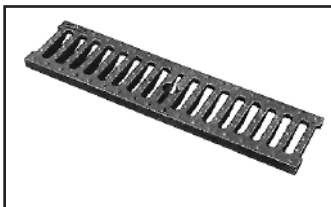

Reference	Dimensions (mm)			Waterway area dm ²	Mass kg
	Length	Width	Depth		

■ GRATINGS 500 X 124

Thickness = 20 mm						
C 250	ECCL12PX	500	124	20	3,0	3,5
D 400	EDCL51PX	500	124	28.5	2,6	4,5
E 600	EECL12PX	500	124	28.5	2,6	4,5

Connecting device: 168044.

■ FRAME FOR GRATINGS 500 X 124

	EECL120	500	164	50	-	3
--	---------	-----	-----	----	---	---

ODOR-TIGHT INLETS PAG

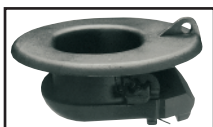

This device, fitted in shafts topped with all types of gratings, acts as an inlet and prevents the escape of smells. For shafts with inside dimensions of 500 and 700 mm.

	Reference	Mass kg		Dimensions mm	
		Total	Cover	Overall	Clear opening
PAG n°2	ECPG452X	44	-	540 x 525	456
PAG n°3	ECPG593X	80	-	738 x 738	590

Longitudinal channel gratings

AUTOLINEA D 400



Functional diagrams of AUTOLINEA C 250 locking/unlocking

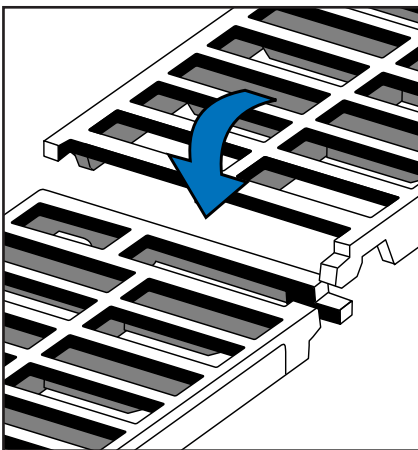

SIMPLE !

Easy to install.
Gratings are simply snapped into place through a ductile spring lock.
With AUTOLINEA, no accessories are needed.

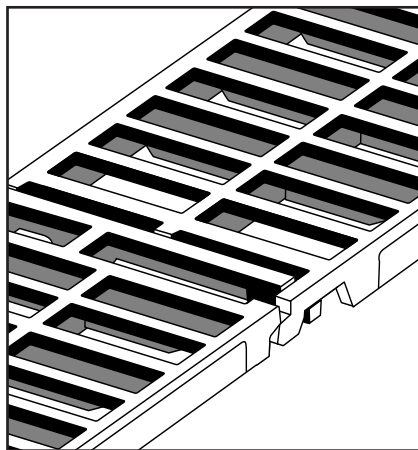

SAFE !

AUTOLINEA provides safety in service :

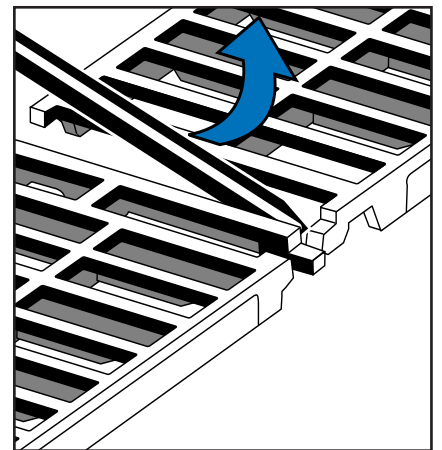

- no danger of accidental displacement,
- limit vandalism,
- anti-dilatation effects.



QUICK !

Removal by professionals is instantaneous, using a crowbar as a lever.

AUTOLINEA - D 400 and C 250

- Ductile iron
Classes D 400, C 250
Automatic ductile iron spring bar,
patented system
EN 124  

A brand new generation of channel gratings, AUTOLINEA gratings are linked together by a ductile iron spring bar. They are usually installed on cast iron T section frames or steel angle fittings which protect the concrete channel and maintain the support level.



■ AUTOLINEA D 400

► **FIELD OF APPLICATION :**
Channels located at the side of motorways and roads carrying intense traffic, excluding singular points which may be subject to crosswise traffic, such as : interchanges, lay-bys, and telephone call stations, breaks in central reservations and crossroads, in which case the TRANSLINEA grating designed for crossing carriageway are required. (See page 52).

Reference	Base size	Mass kg	Dimensions mm			Waterway area dm ²
			Clear opening*	Depth	Thickness	
EDAL30PF	750 x 300	22.9	250	60	35	10.8
EDAL40PF	750 x 400	33	350	85		15
EDAL50PF	750 x 500	43	450			20

Cast iron frame pieces : see page 52.

■ AUTOLINEA C 250



► **FIELD OF APPLICATION :**
Street channels along pavements, excluding singular points which may be subject to crosswise traffic in the field of class C 250 and for which the linked MECALINEA grating is required. (See page 53).

Reference	Base size	Mass kg	Dimensions mm			Waterway area dm ²
			Clear opening*	Depth	Thickness	
ECAL20PF	750 x 200	13	150	35	30	7.6
ECAL25PF	750 x 250	18	200	50		9
ECAL30PF	750 x 300	22	250	56		11.2
ECAL40PF	750 x 400	24.8	350	75		15
ECAL50PF	750 x 500	39	450	80		20.4
ECAL60PF	750 x 600	49.5	550	85		24.6
ECAL70PF	750 x 700	60	650	85		28.4

* when using cast iron T section frame

Gratings for crosswise channels

TRANSLINEA - E 600 AND D 400

- Ductile iron
- Classes E 600, D 400
- Mechanical chaining
- Securing to channel
- EN 124  

TRANSLINEA gratings are used, above all, for crossing carriageways.

They must be installed with the chaining devices joining the gratings together and the end pieces securing the gratings to the channel. This complete, modular system ensures optimum safety under traffic load. Please see the fitting instructions.



TRANSLINEA E 600

- ▶ **Field of application :** All areas involving high axle loads such as: aircraft and port areas, plants, in particular.

Class	Reference	Base size	Mass kg	Dimensions mm			Waterway area dm ²
				Clear opening*	Depth	Area	
E 600	EETL40PF	750 x 400	46	350	85	35	12.9

TRANSLINEA D 400

- ▶ **Field of application :** all carriageway crossing points, roads carrying intense traffic and other singular points such as : interchanges, lay-bys and telephone call stations, breaks in central reservation and crossroads.

D 400	EDTL40PF	750 x 400	47	350	85	35	12.9
-------	----------	-----------	----	-----	----	----	------

* when using cast iron T section frame

CAST IRON T SECTION FRAME FOR AUTOLINEA D 400 AND TRANSLINEA E 600 / D 400

Type	Reference	Mass kg	Dimensions mm	
			Length	Depth
Length 750 mm	E7	10	750	100

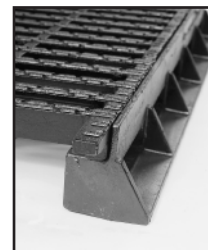

Note : To ensure that channel gratings in classes D 400 and E 600 provide optimum strength and stability when subjected to traffic stresses,  approval is granted to complete units comprising the grating, its cast iron T section frame and, where applicable cast iron end pieces.



If other types of T section frame or angle fitting are used, i.e. steel in particular, their dimensioning and their anchoring in the masonry must be ensured by the specifier, taking into account the stresses due to traffic.

T SECTION FRAME AND ACCESSORIES SPECIFIC TO TRANSLINEA E 600 / D 400

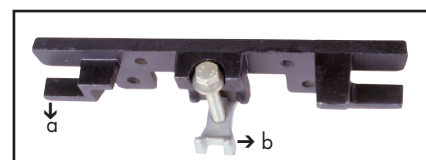
T section frame piece 800 mm long	E8	10.6	800	100
Cast iron end piece (a)	E10	4.4	400	85
Chaining device (b)	E9			



MECALINEA

- Ductile iron
- Class C 250
- Chaining of gratings
- EN 124  

MECALINEA gratings are traditional gratings with mechanical chaining that are installed on cast iron T section frame or steel angle fittings.

► Field of application : as per class C 250 : street channels along the side of pavements and, in particular, singular points which may be subject to crosswise traffic and where chaining is necessary.

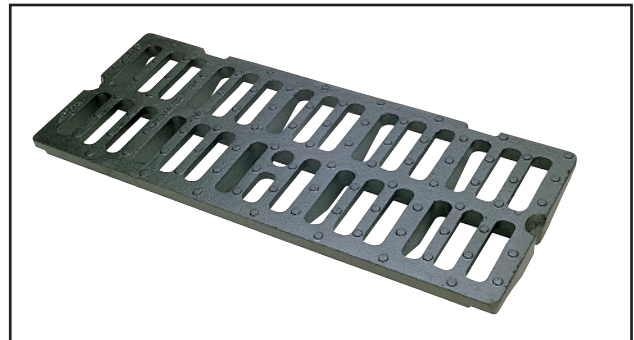
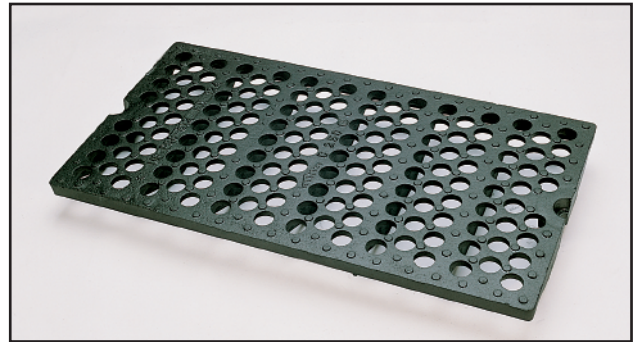

GRATINGS WITH BARS

Reference	Base size mm	Mass kg	Dimensions mm			Waterway area dm ²
			Clear opening*	Depth	Thickness	
ECML20PF	750 x 200	16.1	150	40	27	5.8
ECML25PF	750 x 250	21.5	200	45		6.8
ECML30PF	750 x 300	26	250	50		9
ECML35PF	750 x 350	30	300	60		10.2
ECML40PF	750 x 400	35	350	60		12.9
ECML50PF	750 x 500	42	450	55		15.9
ECML60PF	750 x 600	54	550	60		18.9
ECML70PF	750 x 700	67	550	65		21.8
ECML40RF	750 x 400	35	350	60	27	11.8
ECML60RF	750 x 600	54	550	60		18.6

GRATINGS WITH ROUND HOLES

* when using cast iron T section frame

ACCESSORIES FOR MECALINEA GRATINGS

Type	Reference	Mass kg	Dimensions mm	
			Length	Depth
Frame pieces	E5	4	750	27
Connecting piece	E6	0.5	-	75



Slot drainage channel system

LINEA SLOT BY GATIC

LINEA SLOT by GATIC

A complete galvanized steel system.
Great absorption capacity validated by a dedicated dimensioning software.
Fast and safe installation: 3 m length elements.
Do not hesitate to ask the specific catalog or the preparation of a technical layout for your project.

Surface Boxes

PAM proposes four separate product ranges which cater to different requirements.
Specific catalogue available on request

PAVA EXTENDABLE SURFACE BOXES

PAVA surface boxes feature **built-in extension capabilities**
 The lower base of the body features screw-nut type threads and is designed to allow the unit to be raised during road resurfacing operations by simply "unscrewing" the assembly.

The design includes

- A self-locking system which prevents the lid from being removed by street cleaning equipment or by acts of vandalism
- A wide base reduces the risk of subsidence under traffic loads: stability and silence of the lid on its seat
- Side bonding ribs at the base of the body to prevent rotation during extension operations



Round

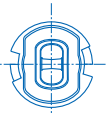

Square

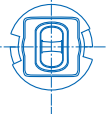

Rectangular

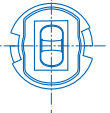

Hexagonal



Type	H1	H2	∅ DI	A	C	∅ DI'	∅ B	D	Mass	Extendibility	Reference
PAVA 10	145	145	102	240	220	137	114	147	8.4	105	F1PVAC
PAVA 14	250	250	102	240	220	137	114	147	13.1	184	F2PVAC
PAVA 19	192	222	120	300	282	148	162	216	19	140	F3PVAC

* Other lid versions and options (shape and chain) are available: please contact us for details

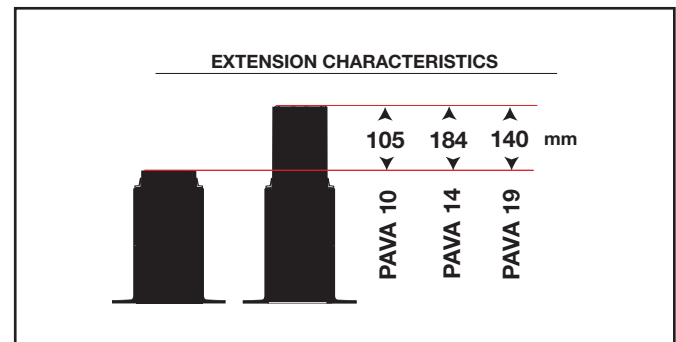
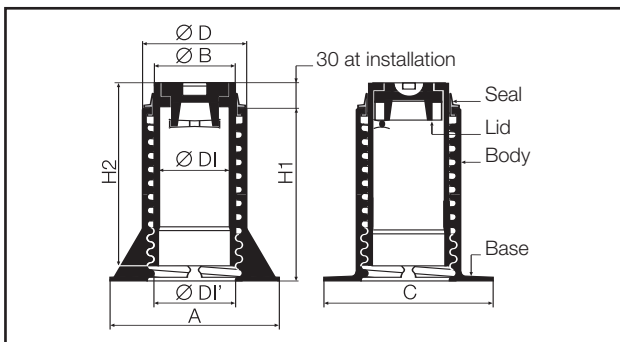

Designed to simplify the extension operation, the lids of the PAVA 10 and 14 can be turned over and used as a tool to limit the operating force. Equipped with two studs forming an operating nut, the inside face of the lid can be used to adjust the extension height using a plain 30 mm wrench or with a Tee wrench used for valve operation. The PAVA 19 requires the use of a specific operating lid. Reference: F3PVRCT



TOTALE SURFACE BOXES RANGE

Two versions are available: "Sidewalks and streets". The base of the "street" version offers a wide bearing surface for enhanced stability under traffic loads.

Surface boxes with "water" badging have a hook-opener type lid with no through hole, chainless*

Type	H	ø A	ø DI	ø E	ø D	Mass	References		
							Round	Square	Hexagonal
Sidewalk	160	150	102	77	120	3.3	FTTOAB	FTTOBB	FTTODB
Street	160	210	102	77	140	5.2	FRTOAB	FRTOBB	FRTODB
Extension	166	74	63	63	170	3.6	FRTO63U	FRTO63V	FRTO63W

*Other lid versions and options are available: please consult us for details

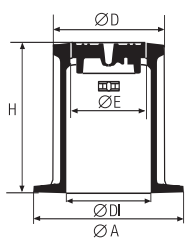

Sidewalk

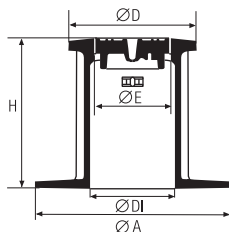

Street

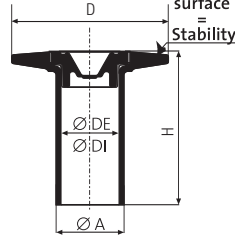

Extension



THE TOTALE MAXI SURFACE BOXES

Type	H	ø A	ø DI	ø E	ø D	Mass	References
Street round	180	250 x 220	102	84	140	6.4	FRXBACT
Street hexagonal	180	250 x 220	102	84	140	6.4	FRXBDCT
Street square	180	250 x 220	102	84	140	6.5	FRXBBCT

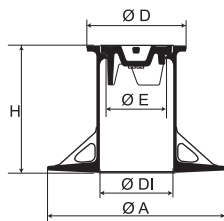

HEIGHT ADJUSTABLE SURFACE BOXES

Height adjustable surface boxes (used as Extension for TOTAL MAXI)

Type	H	ø A	ø DI	ø E	ø D	Mass	References
Round	370	81	68	68	200	7	FRRHACT
Square	370	81	68	68	200	6.75	FRRHBCT
Hexagonal	370	81	68	68	200	7	FRRHDCT

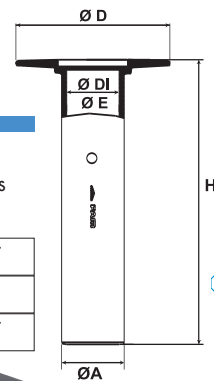

ACCESSORIES

Type	Reference
Hammer for surface box	162 098



